

gea

2024 edition



belbagno

ESSENZE POLIMERICHE GEA / GEA POLYMERIC ESSENCES



noce gold

LACCATI OPACHI / MATT LACQUERED

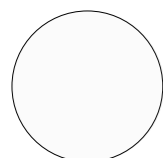

bianco opaco



corda

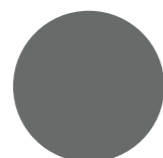

grigio

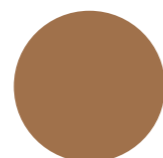

terracotta

LACCATI OPACHI PLUS / MATT LACQUERED PLUS

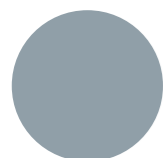

carta da zucchero



verde chiaro



verde pino

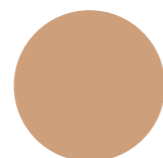

cipria

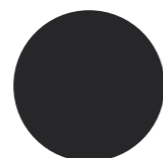

nero

GEA	GEA Basi/Pensili/Colonne <i>Bases/wall units/columns</i>	H.8,7 TOP SCATOLARE <i>Box-shaped top</i>	H.2 TOP CHIUSURA <i>Closing top</i>	PENSILE A GIORNO <i>Opens wall unit</i>	
				MENSOLA <i>Shelf</i>	SCHIENA <i>Back</i>
LACCATI	●	N. D.	●	●	●
LACCATI PLUS	●	N. D.	●	●	●
POLIMERICO NOCE GOLD	●	●	●	N. D.	●
POLIMERICO + MALTA CHIARA	N. D.	●	●	N. D.	N. D.
POLIMERICO + CALACATTA CHIARO	N. D.	●	●	N. D.	N. D.
POLIMERICO + NERO MARQUINIA	N. D.	●	●	N. D.	N. D.
POLIMERICO + OSSIDO	N. D.	●	●	N. D.	N. D.

LIDIA	BASE CANNETTATA CON 1 CASSETTONE 1 CASSETTO E CASSETTA PORTAOGGETTI <i>RIBBED base unit 1 drawer, 1 inner drawer and metal casket glove</i>	BASE CANNETTATA con anta Dx/Sx <i>RIBBED base unit with door R/L</i>		PENSILE A GIORNO METALLO CANNETTATO <i>RIBBED Metal open wall unit</i>
		FRONTALE	FIANCHI	
POLIMERICO NOCE GOLD	●	●	●	●
POLIMERICO ROVERE CHIARO	●	●	●	●
LACCATI	N. D.	N. D.	●	
LACCATI PLUS	N. D.	N. D.	●	

03. gea

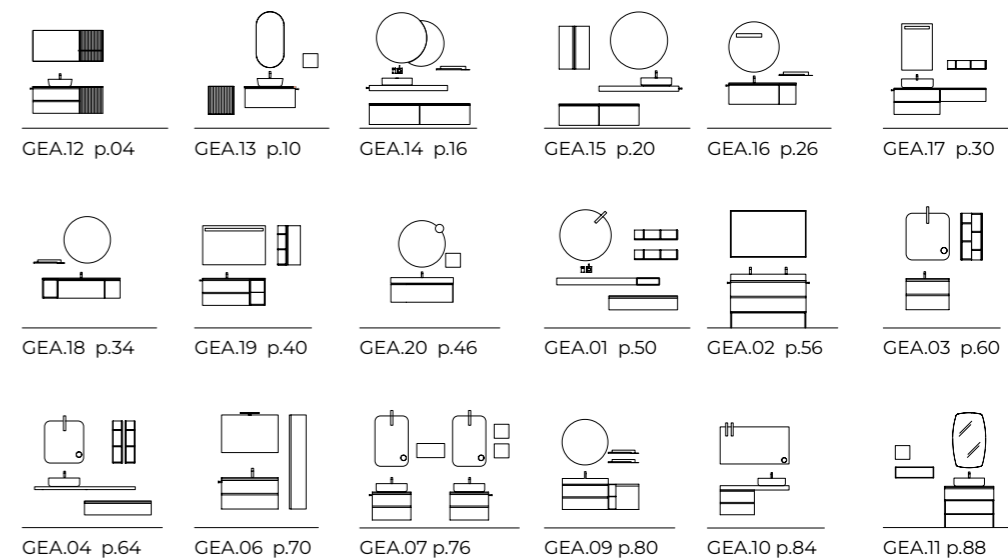

95. listino / pricelist

128. finiture / finishes

130. disegni tecnici / technical drawings

132. condizioni di vendita / sales conditions

composition GEA.12

L 135 H 50 P 46

LIDIA è la collezione accessori che arreda l'ambiente bagno con eleganza e funzionalità. La specchiera illuminata e' composta da una cornice in metallo verniciato nero opaco profonda 12 cm che permette di appoggiare piccoli oggetti. Il pensile a giorno è arricchito dallo schienale in essenza cannettata noce gold. Completa la collezione la base con anta cannettata ad apertura push pull e ripiano interno in vetro.

LIDIA is the accessories collection that furnishes the bathroom with elegance and functionality. The illuminated mirror is made up of a 12cm deep nero opaco painted metal frame which allows you to place small objects. The open wall unit is enriched by the backrest in noce gold ribbed essence. The collection is completed by the base with ribbed door with push-pull opening and internal glass shelf.





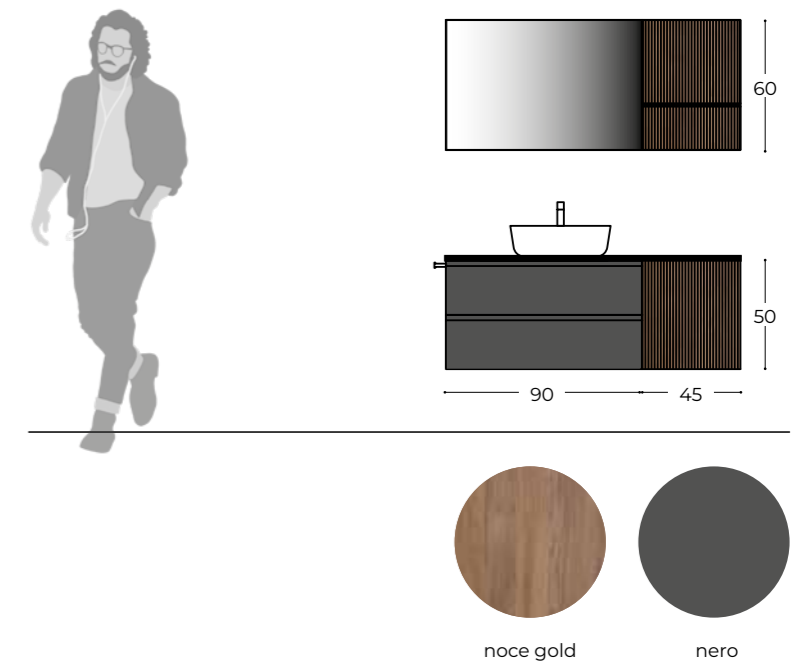

composition GEA.12

L 135 H 50 P 46

G5009C Base portalavabo Cx L.90 H.50 P.46 2 cassettei nero opaco

L5004D Base LIDIA CANNETTATA L.45 H.50 P.46 con anta Dx noce gold

TL1346 Top chiusura L.135 H.2 P.46 polimerico nero marquinia

LSSMART54.05 Lavabo SMART 54 ceramica L.54 H.15 P.34,5 bianco opaco

SL0906L Specchiera metallo LIDIA L.90 H.60 P.12 nero opaco

PGMC45 Pensile a giorno metallo LIDIA CANNETTATO L.45 H.60 P.12 noce gold

PA0400 Maniglione portasciugamani L.40 H.2,5 P.5,5 nero opaco

G5009C Base unit for washbasin Cx W.90 H.50 D.46 2 drawers nero opaco

L5004D RIBBED base unit LIDIA W.45 H.50 D.45 with door R noce gold

TL1346 Closing top W.135 H.2 D.46 polymneric nero marquinia

LSSMART54.05 Washbasin SMART in ceramic W.54 H.15 D.34,5 bianco opaco

SL0906L LIDA lighted mirror W.90 H.60 D.12 nero opaco

PGMC45 Metal open wall unit RIBBED LIDIA W.45 H.60 D.12 noce gold

PA0400 Handle-towel rail W.40 H.2,5 D.5,5 nero opaco

composition GEA.13

L 90/45 H 50/36 P 46



La base LIDIA è disponibile anche nella versione cassettoni con cassetto interno e può essere arricchita da un top in metallo con funzione vassoio portaoggetti. I volumi in movimento del mobile cannettato LIDIA si accostano eleganti alla base portalavabo laccata monocroma con top in vetro in tinta. Completa la collezione la specchiera Hermes con cornice in metallo e illuminazione integrata.

The LIDIA base is also available in the chest of drawers version with internal drawer and can be enriched with a metal top with storage tray function. The moving volumes of the LIDIA ribbed cabinet are elegantly combined with the monochrome lacquered washbasin base with matching glass top. The Hermes mirror with metal frame and integrated lighting completes the collection.



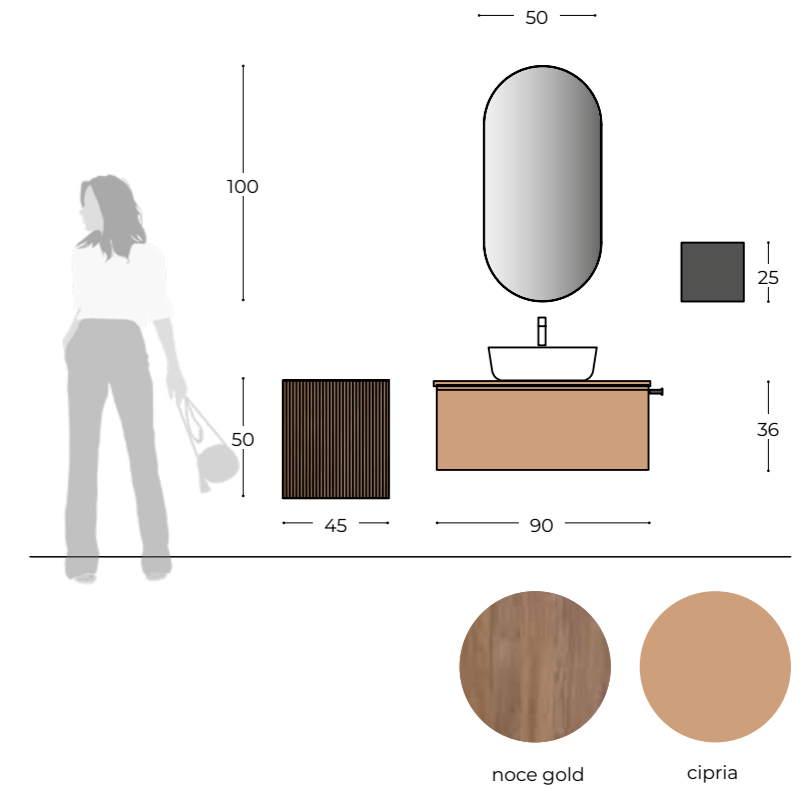

composition GEA.13

L 90/45 H 50/36 P 46

G3609C Base portalavabo Cx L.90 H.36 P.46 1 cassettonc cipria
TV0946 Top chiusura L.90 H.1,2 P.46 cristallo cipria
LSSUN46 Lavabo SUN ceramica L.46 H.14 P.34
SH0510 Specchiera HERMES L.50 H.100 P.6,5 nero op.
CP5004 Base LIDIA CANNETTA L.45 H.50 P.46 noce gold con cassetta portaoggetti metallo nero opaco

PA0400 Maniglione portasciugamani L.40 H.2,5 P.5,5 nero opaco
PGM26 Pensile a giorno metallo L.26,5 H.25 P.12 nero opaco

G3609C Base unit for washbasin Cx W.90 H.36 D.46 1 drawer cipria
TV0946 Glass closing top W.90 H.1,2 D.46 cipria
LSSUN46 Washbasin SUN in ceramic W.46 H.14 D.34
SH0510 HERMES mirror W.50 H.100 D.6,5 nero opaco
CP5004 RIBBED base unit LIDIA W.45 H.50 D.46 noce gold and metal casket glove nero opaco

PA0400 Handle-towel rail W.40 H.2,5 D.5,5 nero opaco
PGM26 Metal open wall unit W.26,5 H.25 D.12 nero opaco

composition GEA.14

L 180 H 36 P 46



La collezione GEA consente infinite soluzioni progettuali: il top scatolare in finitura ossido, profondo e materico, si abbina alle due basi laccate terracotta, nuovo colore caldo e piacevole. Le specchiere retroilluminate SOLE e LUNA aggiungono dinamismo e caratterizzano l'ambiente circostante.

The GEA collection allows infinite design solutions: the box-shaped top in ossido finish, deep and material, matches the two terracotta lacquered bases, a new warm and pleasant colour. The SOLE and LUNA rear lighted mirrors add dynamism and characterize the surrounding environment.

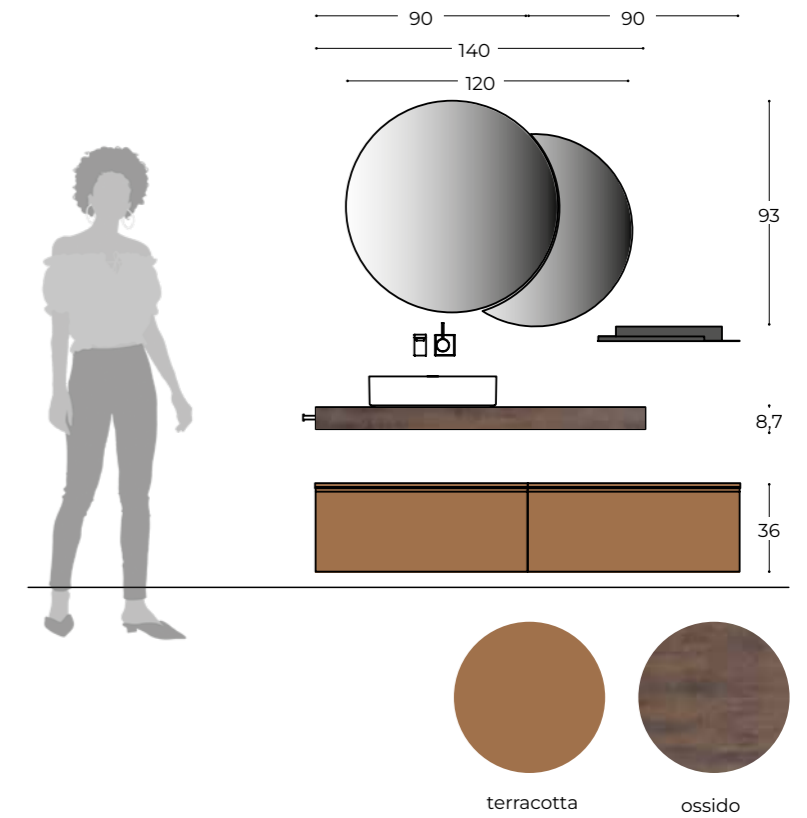

composition GEA.14

L 180 H 36 P 46

TS1440 Top scatolare L.140 H.8,7 P.46 polimerico ossido
SM0000 Staffa di montaggio L.42,5 (x3)
LSSMART54 Lavabo SMART 54 ceramica L.54 H.15 P.34,5 bianco lucido
G36090 Base L.90 H.36 P.46 1 cassettone terracotta (x2)
TL1846 Top chiusura L.180 H.2 P.46 terracotta
SS120L Specchiera SOLE retroilluminata
SL120L Specchiera LUNA retroilluminata

PA0400 Maniglione portasciugamani L.40 H.2,5 P.5,5 nero opaco
MM06 Mensola portaoggetti metallo con ganci L.60 H.6 P.15 nero opaco

TS1440 Box-shaped top W.140 H.8,7 D.46 polimerico ossido
SM0000 Supporting bracket W.42,5 (x3)
LSSMART54 Washbasin SMART 54 in ceramic W.54 H.15 D.34,5 bianco lucido
G36090 Base unit W.90 H.36 D.46 1 drawer terracotta (x2)
TL1846 Closing Top W.180 H.2 D.46 terracotta
SS120L SUN rear lighted mirror
SL120L MOON rear lighted mirror

PA0400 Handle-towel rail W.40 H.2,5 D.5,5 nero opaco
MM06 Metal shelf with hooks W.60 H.6 D.15 nero opaco

composition GEA.15

L 210 H 36 P 46



Il top scatolare contraddistinto da un segno forte e deciso, è disponibile anche nella elegante finitura nero marquinia. Abbinato a due basi accostate laccate nero, arreda con carattere ambienti raffinati e moderni. La specchiera tonda Maia, con cornice in metallo nero verniciato e luce integrata, conferisce allo spazio un'illuminazione omogenea e armoniosa.

The box-shaped top characterized by a strong and decisive sign is also available in the elegant nero marquinia finish. Combined with two side-by-side nero lacquered bases, it furnishes refined and modern environments with character. The Maia round mirror, with a painted nero metal frame and integrated light, gives the space homogeneous and harmonious lighting.



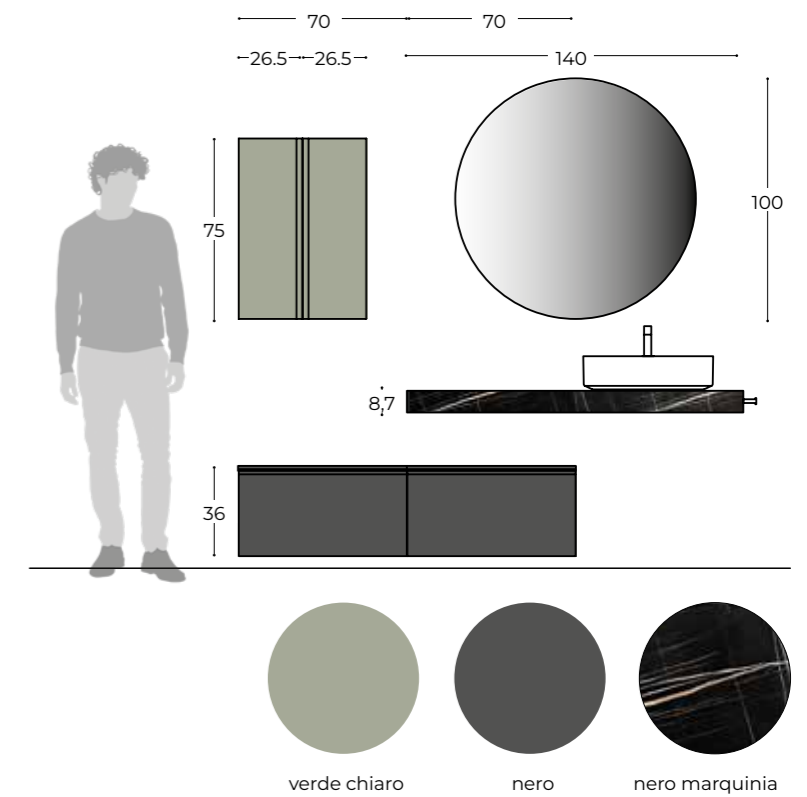

composition GEA.15

L 210 H 36 P 46

TS1440 Top scatolare L.140 H.8,7 P.46 polimerico nero marquina

SM0000 Staffa di montaggio L.42,5 (x3)

LSSMART54 Lavabo SMART 54 ceramica L.54 H.15 P.34,5 bianco lucido

G36070 Base L.70 H.36 P.46 1 cassettono nero op.(x2)

TL1446 Top chiusura L.140 H.2 P.46 nero opaco

SM10L Specchiera MAIA Ø100 P.6,5 nero opaco

PA0400 Maniglione portasciugamani L.40 H.2,5 P.5,5 nero opaco

PG75D Pensile 1 anta Dx L.26,5 H.75 P.20 verde chiaro

PG75S Pensile 1 anta Sx L.26,5 H.75 P.20 verde chiaro

TS1440 Box-shaped top W.140 H.8,7 D.46 polimerico nero marquina

SM0000 Supporting bracket W.42,5 (x3)

LSSMART54 Washbasin SMART 54 in ceramic W.54 H.15 P.34,5 bianco lucido

G36070 Base unit W.70 H.36 D.46 1 drawer nero op.(x2)

TL1446 Closing Top W.140 H.2 D.46 nero opaco

SM10L MAIA lighted mirror Ø100 nero opaco D.6,5

PA0400 Handle-towel rail W.40 H.2,5 D.5,5 nero opaco

PG75D Wall unit W.26,5 H.75 D.20 1 door R verde chiaro

PG75S Wall unit W.26,5 H.75 D.20 1 door L verde chiaro

composition GEA.16

L 120 H 36 P 46



La collezione GEA interpreta anche gli ambienti più minimali con personalità e raffinatezza. In questa proposta compositiva dalle linee pulite e decise, si distinguono le due basi laccate bianco e il lavabo in mineral marmo, abbinato alla mensolina portaoggetti e al maniglione portasciugamani, entrambi in nero.

The GEA collection interprets even the most minimal environments with personality and refinement. In this compositional proposal with clean and decisive lines, the two white lacquered bases and the mineral marble washbasin stand out, combined with the storage shelf and the towel rail, both in nero.

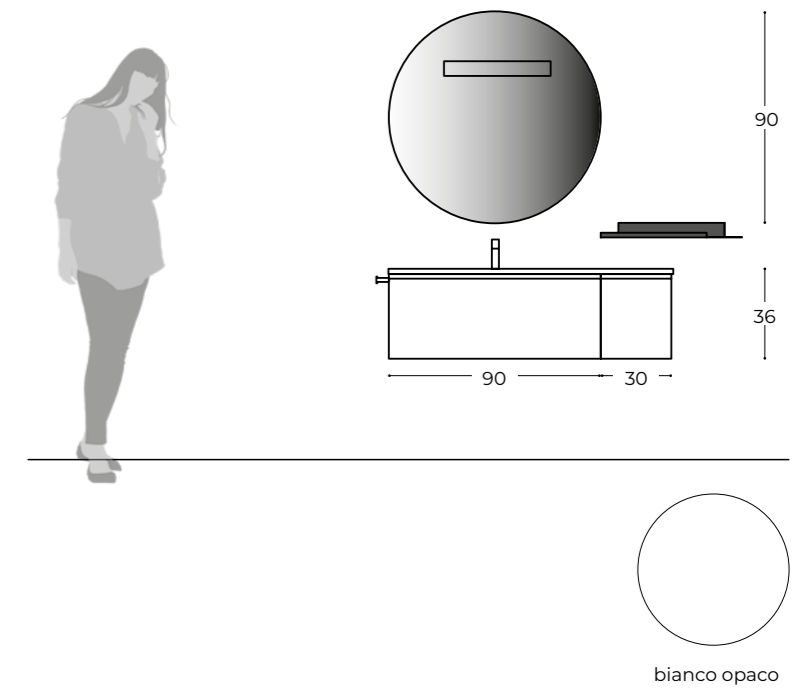

composition GEA.16

L 120 H 36 P 46

G3609C Base portalavabo CX L.90 H.36 P.46 1 cassettone bianco opaco
G3603D Base L.30 H.36 P.46 1 anta Dx bianco opaco
L49030SMO Lavabo mineralmarmo L.120 (90+30) H.1,3 P.46 VASCA SX bianco opaco
SS09RL Specchiera SOFIA illuminata tonda Ø90 P.4,8

MM06 Mensola portaoggetti metallo con ganci L.60 H.6 P.15 nero opaco

PA0400 Maniglione portasciugamani L.40 H.2,5 P.5,5 nero opaco

G3609C Base unit for washbasin Cx W.90 H.36 D.46 1 drawer bianco opaco
G3603D Base unit W.30 H.36 P.46 with door R bianco op.
L49030SMO Washbasin in mineralmarble W.120 (90+30) H.1,3 D.46 LEFT BASIN bianco opaco
SS09RL SOFIA round lighted mirror Ø90 D.4,8

MM06 Metal shelf with hooks W.60 H.6 D.15 nero opaco

PA0400 Handle-towel rail W.40 H.2,5 D.5,5 nero opaco

composition GEA.17

L 180 H 50 P 46



La collezione GEA soddisfa anche le personalità più estroverse grazie alla sua ampia modularità e possibilità compositiva. Le basi asimmetriche laccate verde chiaro abbinata al pensile a giorno orizzontale, generano un movimento armonioso e rilassante. Il top in polimerico finitura marmo calacatta assicura igiene e facilità di pulizia.

The GEA collection satisfies even the most extroverted personalities thanks to its wide modularity and compositional possibilities. The asymmetrical verde chiaro lacquered bases combined with the horizontal open wall unit generate a harmonious and relaxing movement. The calacatta marble finish polymer top ensures hygiene and ease of cleaning.

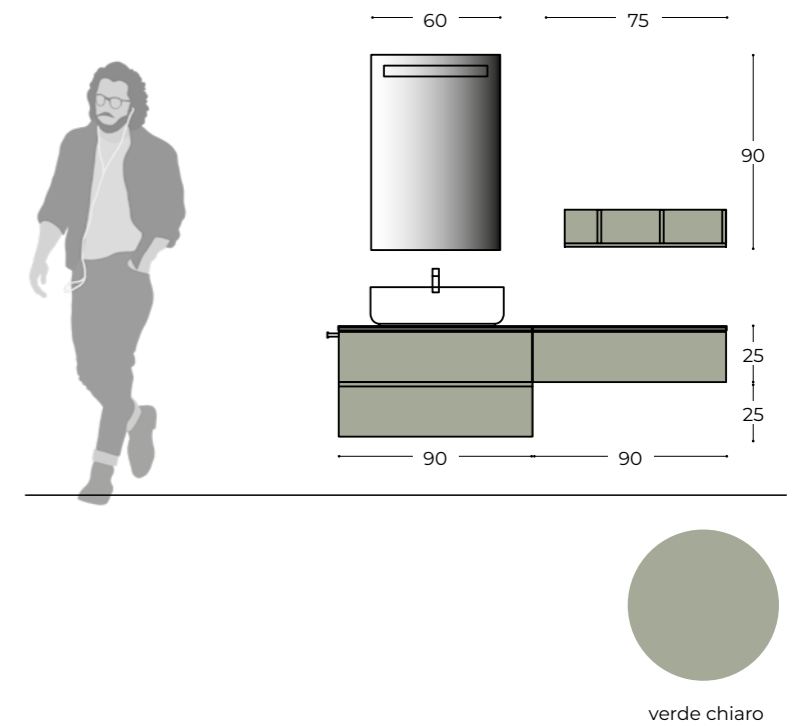

composition GEA.17

L 180 H 50 P 46

G5009C Base portalavabo Cx L.90 H.50 P.46 2 cassetti verde chiaro

G25090 Base L.90 H.25 P.46 1 cassetto verde chiaro

TL1846 Top chiusura L.180 H.2 P.46 polimerico marmo calacatta

LSNICE55.00 Lavabo NICE ceramica L.55 H.15 P.35,5 bianco lucido

SS060L Specchiera SOFIA illuminata rettangolare L.60 H.90 P.4,8

PA0400 Maniglione portasciugamani L.40 H.2,5 P.5,5 cromo

PG75DO1 Pensile a giorno Dx orizzontale L.75 H.17 P.15 verde chiaro

G5009C Base unit for washbasin Cx W.90 H.50 D.46 2 drawers verde chiaro

G25090 Base unit W.90 H.25 D.46 1 drawer verde chiaro

TL1846 Polymneric closing top W.180 H.2 D.46 polimerico marmo calacatta

LSNICE55.00 Washbasin NICE in ceramic W.55 H.15 D.35,5 bianco lucido

SS060L SOFIA lighted mirror W.60 H.90 D.4,8

PA0400 Handle-towel rail W.40 H.2,5 D.5,5 chrome

PG75DO1 Open wall unit R horizontal W.75 H.17 D.15 verde chiaro

composition GEA.18

L 150 H 36 P 46

I nuovi colori di Gea permettono infinite combinazioni cromatiche, come il raffinato abbinamento tono su tono del verde chiaro con il verde pino. Il lavabo in cristallo si integra perfettamente con la nuova base a giorno: una soluzione di volumi in movimento grazie all'alternarsi di pieni e vuoti.

The new Gea colors allow infinite chromatic combinations, such as the refined tone-on-tone combination of verde chiaro with verde pino. The glass washbasin integrates perfectly with the new open base: a solution of moving volumes thanks to the alternation of full and empty spaces.





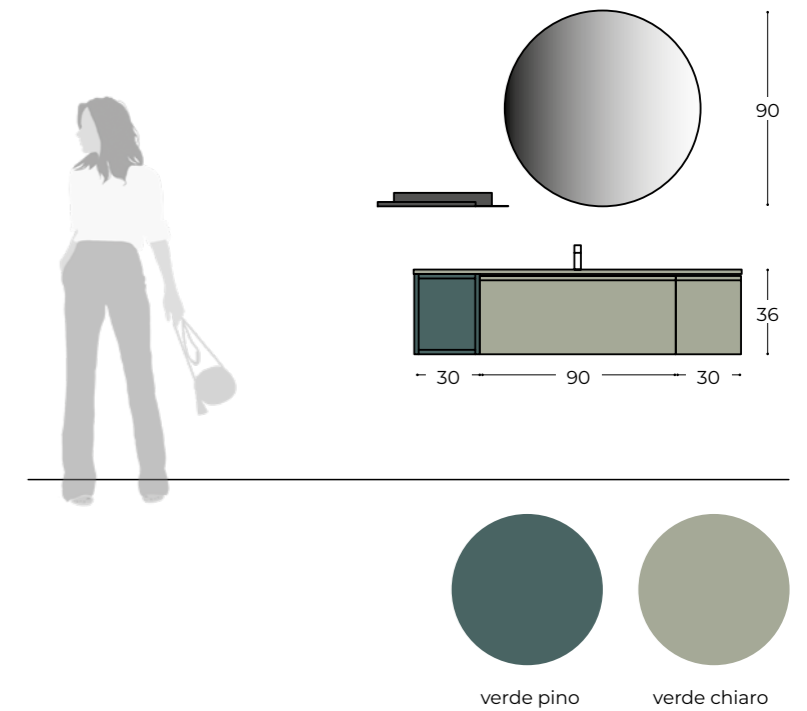

composition GEA.18

L 150 H 36 P 46

G3609C Base portalavabo Cx L.90 H.36 P.46 1 cassettone verde chiaro

G3603D Base L.30 H.36 P.46 con anta Dx verde chiaro

G3603CG Base a giorno L.30 H.36 P.45 verde pino

L415CV Lavabo cristallo L.150 H.1,2 P.46 VASCA CX verde chiaro

SS09RL Specchiera SOFIA illuminata tonda Ø90 P.4,8

MM06 Mensola portaoggetti metallo con ganci L.60 H.6 P.15 nero opaco

G3609C Base unit for washbasin Cx W.90 H.36 D.46 1 drawer verde chiaro

G3603D Base unit W.30 H.36 D.46 with door R verde chiaro

G3603CG Open base unit W.30 H.36 D.45 verde pino

L415CV Glass washbasin W.150 H.1,2 D.46 CENTRAL BASIN verde chiaro

SS09RL SOFIA round lighted mirror Ø90 D.4,8

MM06 Metal shelf with hooks W.60 H.6 D.15 nero opaco

composition GEA.19

L 120 H 50 P 46

La collezione GEA comprende pensili con anta ad apertura laterale, con due ripiani in vetro, che permettono di aumentare lo spazio dedicato al contenimento. I pensili possono essere affiancati da vani a giorno nella stessa finitura che decorano con delicata eleganza.

The GEA collection includes wall units with side-opening doors, with two glass shelves, which allow you to increase the space dedicated to storage. The wall units can be flanked by open compartments in the same finish which they decorate with delicate elegance.

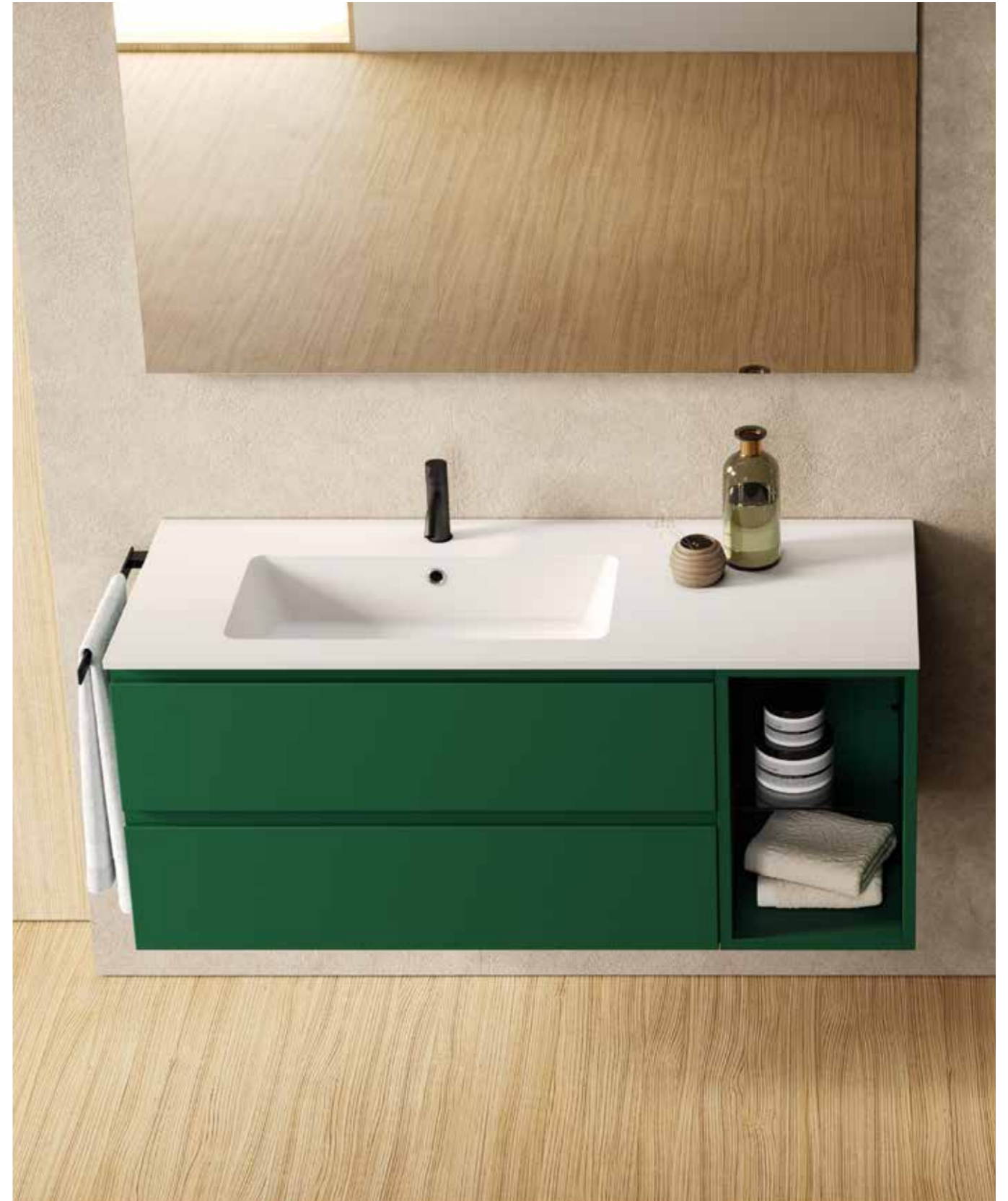



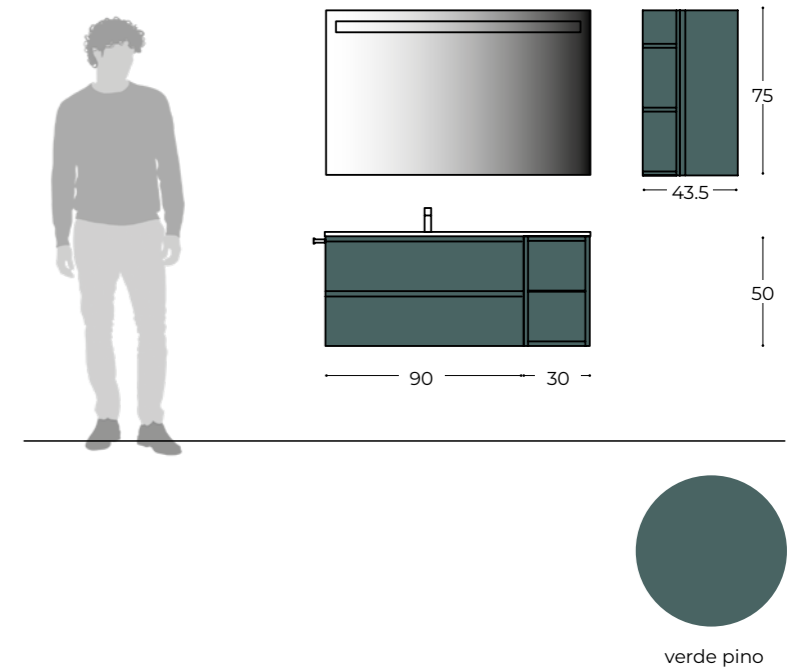

composition GEA.19

L 120 H 50 P 46

G5009C Base portalavabo Cx L.90 H.50 P.46 2 cassetti verde pino

G5003CG Base a giorno L.30 H.50 P.45 verde pino

L49030SMO Lavabo mineralmarmo L.120 (90+30) H.1,3 P.46 VASCA SX bianco opaco

SS120L Specchiera SOFIA illuminata L.120 H.75 P.4,8

PG75D Pensile 1 anta Dx L.26,5 H.75 P.20 verde pino

PG75SV1 Pensile a giorno Sx verticale L.17 P.15 verde pino

PA0400 Maniglione portasciugamani L.40 H.2,5 P.5,5 nero opaco

G5009C Base unit for washbasin Cx W.90 H.50 D.46 2 drawers verde pino

G5003CG Open base unit W.30 H.50 D.45 verde pino

L49030SMO Washbasin in mineralmarble W.120 (90+30) H.1,3 D.46 LEFT BASIN bianco opaco

SS120L SOFIA lighted mirror W.120 H.75 D.4,8

PG75D Wall unit W.26,5 H.75 D.20 1 door R verde pino

PG75SV1 Open wall unit L vertical W.17 D.15 verde pino

PA0400 Handle-towel rail W.40 H.2,5 D.5,5 nero opaco

composition GEA.20

L 120 H 36 P 46



Le linee pulite ed essenziali dei cassetti sono esaltate dal caldo e intenso colore terracotta abbinato al lavabo SHARK in mineral bianco opaco. Lo specchio tondo è contraddistinto dalla lampada led ROUND che può essere posizionata a piacere lungo tutta la circonferenza.

The clean and essential lines of the drawers are enhanced by the warm and intense terracotta color combined with the SHARK washbasin in matt white mineral. The round mirror is characterized by the ROUND LED lamp which can be positioned as desired along the entire circumference.

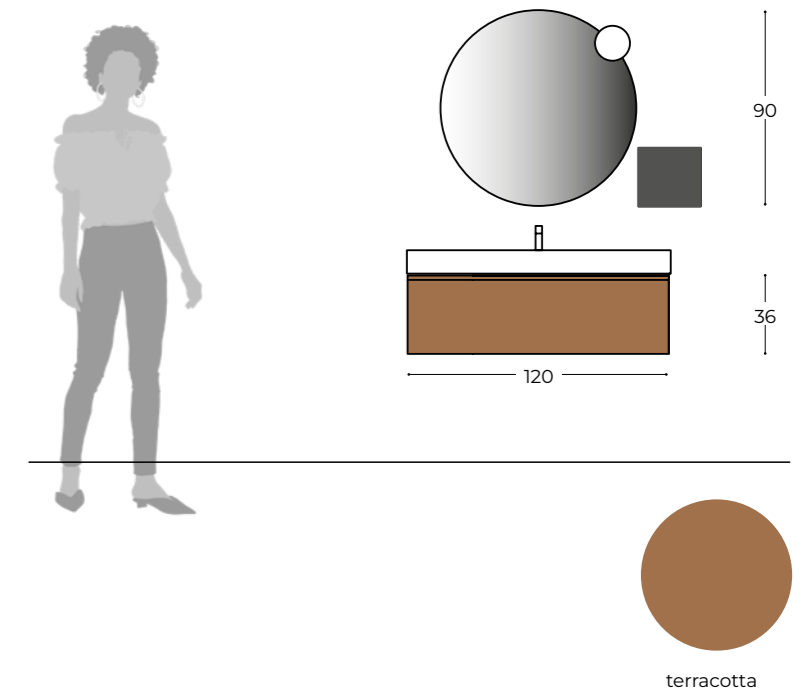

composition GEA.20

L.120 H.36 P.46

G3612C Base portlavabo Cx L.120 H.36 P.46 1 cassettone terracotta

LSH12C Lavabo SHARK mineralmarmo L.120,5 H.10 P.46 VASCA CX bianco opaco

ST09S Specchiera tonda filo lucido Ø90

LR00 Lampada ROUND Ø10

PGM26 Pensile a giorno metallo L.26,5 H.25 P.12 nero opaco

PA0400 Maniglione portasciugamani L.40 H.2,5 P.5,5 nero opaco

G3612C Base unit for washbasin Cx W.120 H.36 D.46 1 drawer terracotta

LSH12C Washbasin SHARK mineralmarble W.120,5 H.10 D.46 CENTRAL BASIN bianco opaco

ST09S Round polished edge mirror Ø90

LR00 Led lamp ROUND Ø10

PGM26 Metal open wall unit W.26,5 H.25 D.12 nero opaco

PA0400 Handle-towel rail W.40 H.2,5 D.5,5 nero opaco

composition GEA.01

L 210 H 25 P 46

In un unico volume il lavabo in ocritech integra una comoda asola portasalviette laterale e un vano a giorno: una soluzione che unisce design e funzionalità. La retroilluminazione della specchiera ARCO è garantita da un elegante interruttore touch.

In a single volume, the Ocritch washbasin integrates a convenient side towel holder slot and an open compartment: a solution that combines design and functionality. The rear lighting of the ARCO mirror is guaranteed by an elegant touch switch.





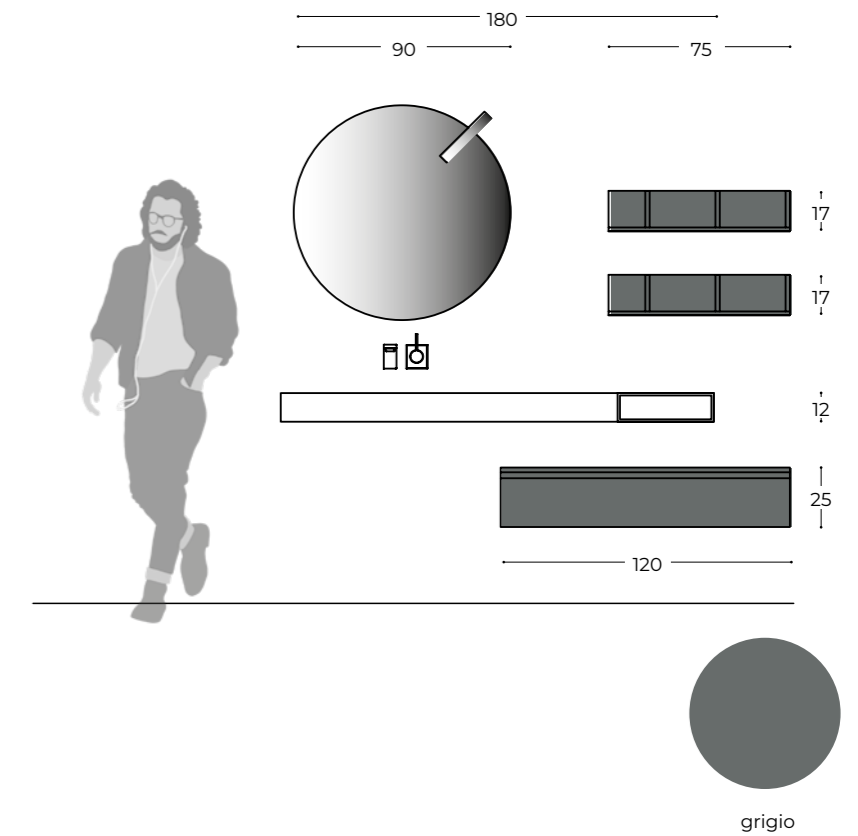

composition GEA.01

L 210 H 25 P 46

G25120 Base L.120 H.25 P.46 1 cassetto grigio opaco
TL1246 Top chiusura L.120 H.2 P.46 grigio opaco
LO18S4 Lavabo Ocritech L.180 H.12 P.46 vasca SX
VGO Vano a giorno Ocritech L.40 H.10 P.40
APSLO Asola portasalviette laterale Ocritech
SM0000 Staffa di montaggio L.42,5 (x3)
SA090L Specchiera ARCO retroilluminata Ø90
T Interruttore TOUCH per specchiera
LT03 Lampada led TWO-FACES L.4 H.30 P.2

PG75DO1 Pensile a giorno GEA 75 DX grigio opaco (x2)

G25120 Base unit W.120 H.25 D.46 1 drawer grigio opaco
TL1246 Closing top W.120 H.2 D.46 grigio opaco
LO18S4 Integral Washbasin Ocritech W.180 H.12 D.46 left
VGO Open unit Ocritech W.40 H.10 P.40
APSLO Towel side hole Ocritech
SM0000 Supporting brackets W. 42,5 (x3)
SA090L Rear lighted mirror ARCO Ø90
T Touch switch for mirror
LT03 Led lamp TWO-FACES W.4 H.30 D.2

PG75DO1 Open wall units GEA 75 right grigio opaco gray (x2)

composition GEA.02

L 120 H 85 P 46

GEA e' disponibile anche nella versione con struttura in alluminio nero opaco in coordinato con gli accessori bagno. Il portasciugamani VELA coniuga perfettamente funzionalità con estetica e design. Le sue linee pulite definiscono il mobile bagno e la sua forma distintiva permette una migliore aerazione della salvietta favorendone una veloce asciugatura.

GEA is also available in the version with a nero opaco aluminum structure coordinated with the bathroom accessories. The VELA towel rail perfectly combines functionality with aesthetics and design. Its clean lines define the bathroom furniture and its distinctive shape allows better ventilation of the towel, promoting quick drying.





composition GEA.02

L 120 H 85 P 46

AB2512 Struttura alluminio base L.120 H.25 P.46
nero opaco

G5012V Base portalavabo 2 vasche L.120 H.50 P.46
2 cassetti noce gold

LSH12V Lavabo integrale SHARK mineralmarmo
L.120,5 H.10 P.46 vasca doppia bianco opaco

SC124L Specchiera CASSANDRA L.120 H.75
illuminata 4 lati nero opaco

PAV04 Portasciugamani laterale VELA L.40 nero
opaco (x2).

AB2512 Aluminum structure for base W.120 H.25
D.46 matt black

G5012V Base unit for washbasin W.120 H.50 D.46
DOUBLE BASIN 2 drawers noce gold

LSH12V Integral washbasin SHARK in mineralmar-
ble W.120 H.10 D.46 DOUBLE BASIN bianco opaco

SC124L Mirror CASSANDRA W.120 H.75 lighted 4
sides nero opaco

PAV04 Side towel rails VELA W.40 H.4,5 D.7 nero
opaco (x2)

composition GEA.03

L 70 H 50 P 46



L'alternarsi di linee verticali e orizzontali sono gli elementi caratterizzanti dei due pensili a giorno GEA, con schiena noce gold e mensole laccate bianco opaco. La specchiera ALFA retroilluminata con interruttore touch, è personalizzata grazie alla lampada TWO-FACES e allo specchio ingranditore calamitato.

The alternation of vertical and horizontal lines are the characterizing elements of the two GEA open wall units, with noce gold back and bianco opaco lacquered shelves.

The rear lighted ALFA mirror with touch switch is customized thanks to the TWO-FACES lamp and the magnetic magnifying mirror.

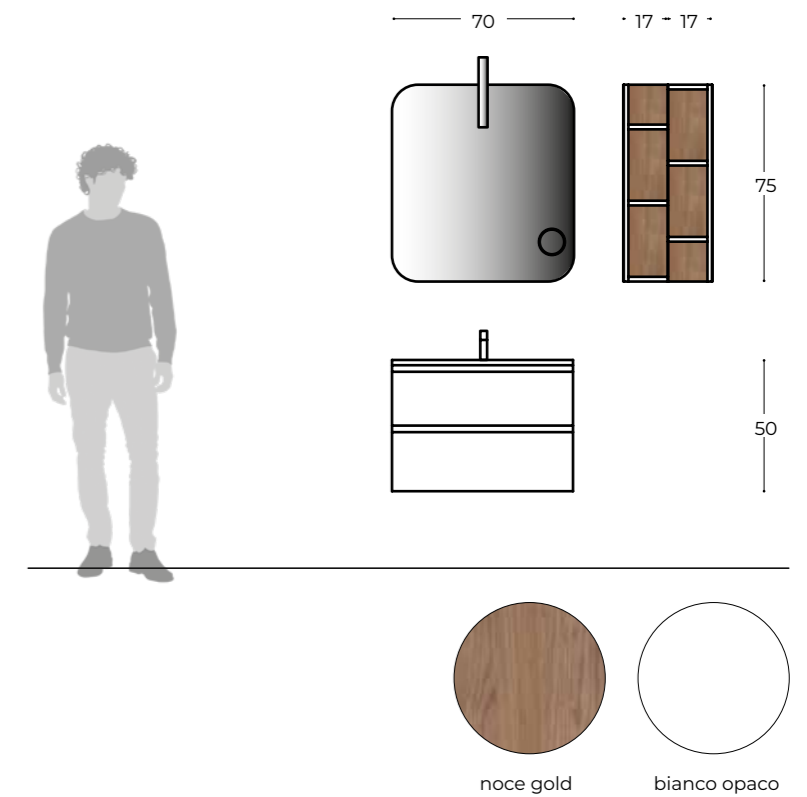

composition GEA.03

L 70 H 50 P 46

G5007C Base portalavabo CX L.70 H.50 P.46 2 cassettei bianco opaco

LEA07CC Lavabo integrale ceramica L.70 H.1,3 P.46 vasca cx

SAL07L Specchiera ALFA retroilluminata L.70 H.75

T TOUCH Interruttore TOUCH per specchiera

LT03 Lampada led TWO-FACES L.4 H.30 P.2

PG75DV2 Pensile a giorno L.17 H.75 P.15 Dx schiena noce gold mensole bianco opaco (X2)

ASI Specchio ingranditore calamitato Ø15

G5007C Base unit for washbasin Cx W.70 H.50 D.46 2 drawers bianco opaco

LEA07CC Ceramic integral washbasin W.70 H.1,3 D.46 CENTRAL BASIN

SAL07L Rear lighted mirror ALFA W.70 H.75

T TOUCH switch for mirror

LT03 Led lamp TWO-FACES W.4 H.30 D.2

PG75DV2 Open wall unit W.17 H.75 D.15 R noce gold back panel and bianco opaco shelves (x2)

ASI Magnetised magnifying mirror Ø15

composition GEA.04

L 120 H 25 P 46

Le composizioni GEA possono essere impreziosite dal top in rovere massello effetto corteccia. Un elemento dal grande impatto estetico che richiama la natura e le sue atmosfere rilassanti. In appoggio il lavabo NICE in ceramica bianca opaca con piletta in tinta.

GEA compositions can be embellished with a bark-effect solid oak top. An element with a great aesthetic impact that recalls nature and its relaxing atmospheres. On top of it is the NICE washbasin in bianco opaco ceramic with matching drain.

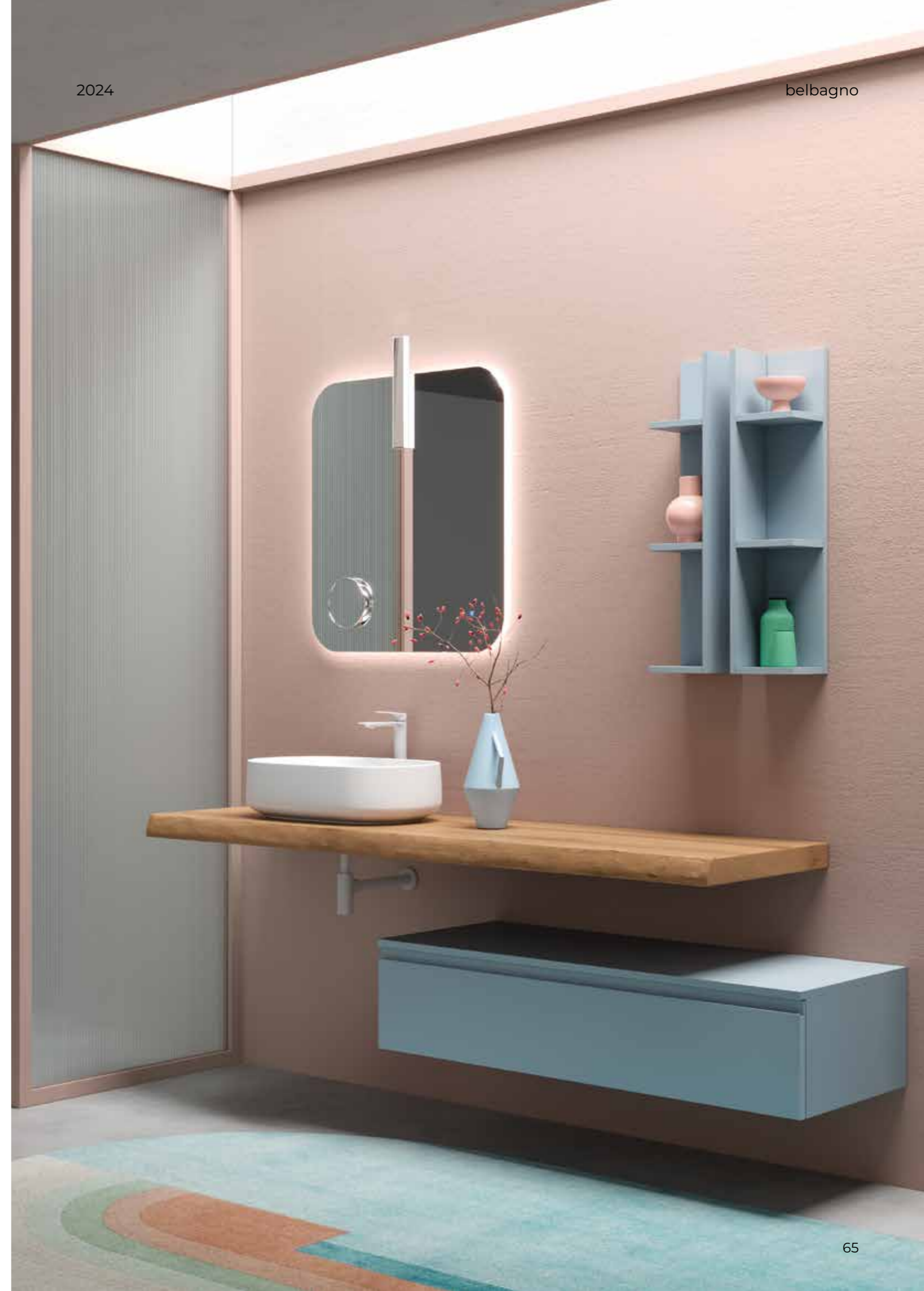



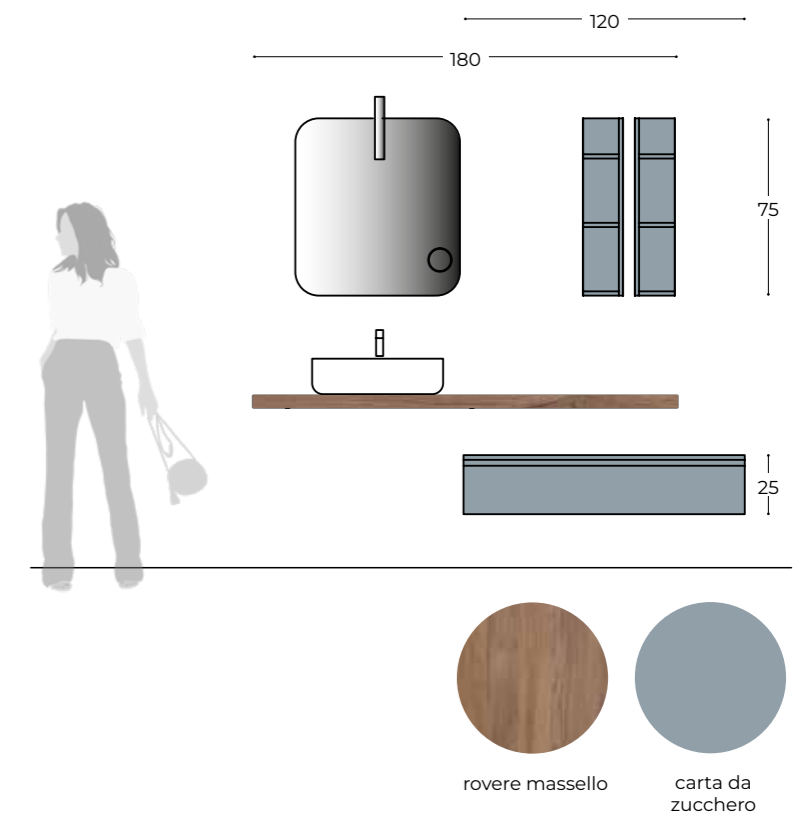

composition GEA.04

L 210 H 25 P 46

G25120 Base L.120 H.25 P.46 1 cassetto carta da zucchero
TL1246 Top L.120 H.2 P.46 carta da zucchero
TM Top in rovere massello SP.5 L.180 P.46 effetto corteccia
STM Staffe per top massello (X3)
LSNICE55.05 Lavabo appoggio NICE ceramica L.55 H.15 P.35,5 bianco opaco
PC.05 Piletta ceramica bianco opaco
SAL07L Specchiera ALFA retroilluminata L.70 H.75
T TOUCH Interruttore TOUCH per specchiera
LT03 Lampada led TWO-FACES L.4 H.30 P.2

G25120 Base unit W.120 H.25 D.46 1 drawer carta da zucchero
TL1246 Closing top W.120 H.2 D.46 carta da zucchero
TM Solid oak top W.180 H.5 D.46 irregular front edge.bark effect
STM Supporting brackets for solid wood top (x3)
LSNICE55.05 Counter Top basin Nice in ceramic W.55 H.15 D.35,5 bianco opaco
PC.05 Waste basin in ceramic bianco opaco
SAL07L Rear lighted mirror ALFA W.70 H.75
TOUCH switch for mirror
LT03 Led lamp TWO-FACES W.4 H.30 D.2

PG75DV1 Pensile a giorno L.17 H.75 P.15 Dx carta da zuc.
PG75SV1 Pensile a giorno L.17 H.75 P.15 Sx carta da zuc.
ASI Specchio ingranditore calamitato Ø15
PG75DV1 Open wall unit W.17 H.75 D.15 R carta da zucchero
PG75SV1 Open wall unit W.17 H.75 D.15 L carta da zucchero
ASI Magnetised magnifying mirror Ø15

composition GEA.06

L 90/26,5 H 50 P 46

Particolarmente utile per ampliare il contenimento dell'ambiente bagno, la colonna singola è ad anta unica con apertura a gola integrata. Pulita ed essenziale nasconde al suo interno tre comodi ripiani: due in vetro e uno in melaminico.

Particularly useful for expanding containment of the bathroom, the single column has a single door with integrated groove opening. Clean and essential, it hides three comfortable shelves inside: two in glass and one in melamine.





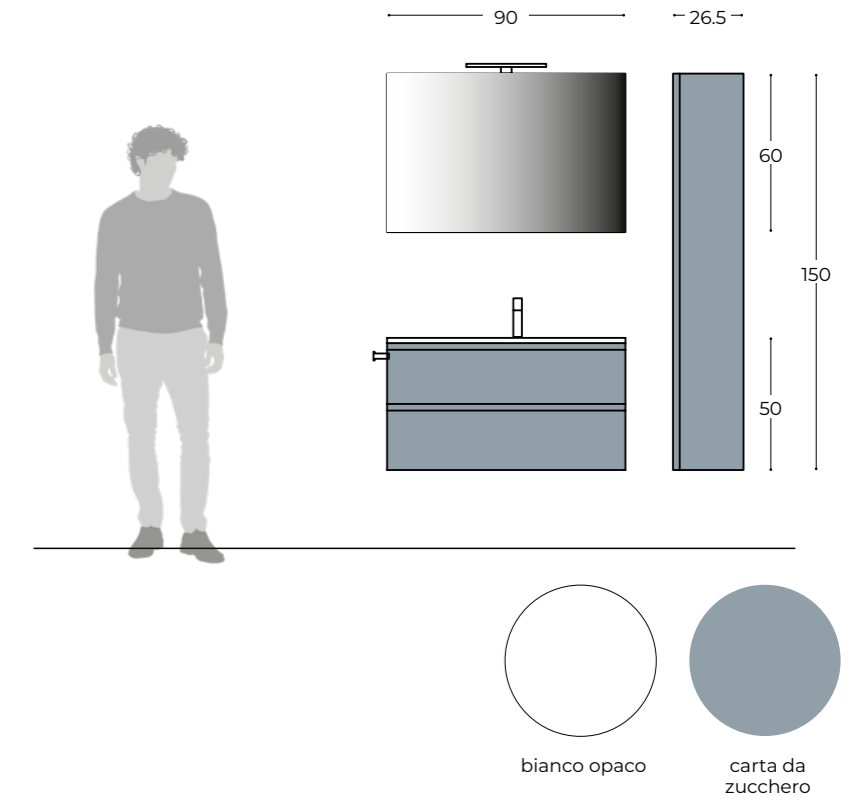

composition GEA.06

L 90/26,5 H 50 P 46

G5009C Base portalavabo Cx L.90 H.50 P.46 2 cassette carta da zucchero

LEA09CC Lavabo integrale ceramica L.90 H.1,3 P.46 VASCA CX

SF0906 Specchiera filo lucido L.90 H.60 P.2,5

KI030L Lampada KIRA led L.30 H.4 P.10

CG15D Colonna 1 anta Dx L.26,5 H.150 P.20 carta da zucchero

PAV04 Portasciugamani laterale VELA L.40 H.4,5 P.7 bianco opaco

G5009C Base unit for washbasin Cx W.90 H.50 D.46 2 drawers carta da zucchero

LEA09CC Ceramic integral washbasin W.90 H.1,3 D.46 CENTRAL BASIN

SF0906 Polished edge mirror W.90 H.60 D.2,5

KI030L Led lamp KIRA W.30 H.4 D.10

CG15D Column 1 door R W.26,5 H.150 D.20 carta da zucchero

PAV04 Side towel rails VELA W.40 H.4,5 D.7 bianco opaco

composition GEA.07

L 70 H 50 P 46



La doppia soluzione compositiva con lavabo in appoggio su top in noce gold garantisce la massima indipendenza e libertà di gestione del proprio spazio intimo. Entrambe le basi portalavabo sono arricchite dal portasciugamani VELA e dai contenitori a giorno in metallo bianco opaco.

The double compositional solution with sink resting on a noce gold top guarantees maximum independence and freedom in managing your intimate space. Both washbasin bases are enriched by the VELA towel rail and the open containers in bianco opaco metal.

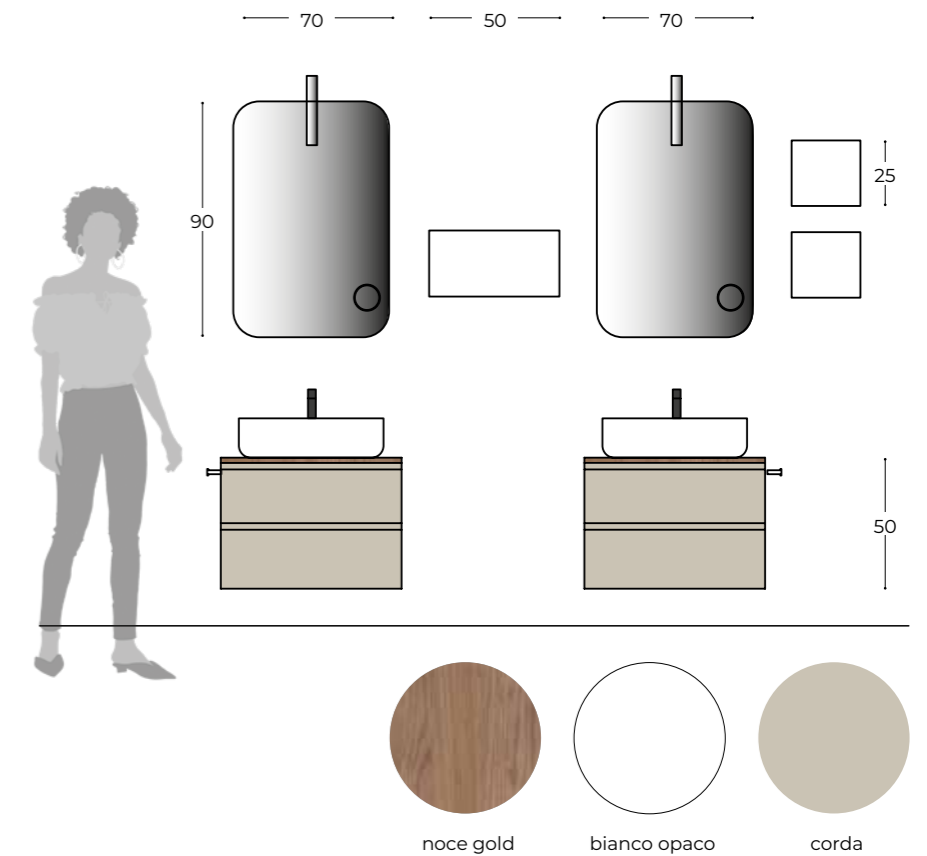

composition GEA.07

L 70 H 50 P 46

G5007C Base portalavabo Cx L.70 H.50 P.46 2 cassetti corda opaco

TL0746 Top chiusura L.70 H.2 P.46 noce gold

LSNICE55.05 Lavabo appoggio NICE ceramica L.55 H.15 P.35,5 bianco opaco

SAL06L Specchiera ALFA Retroilluminata L.60 H.90

T Interruttore TOUCH per specchiera

LT03 Lampada led TWO-FACES L.4 H.30 P.2

ASI Specchio ingranditore calamitato Ø15

PAV04 Portasciugamani laterale VELA L.40 H.4,5 P.7 nero opaco

PGM26 Pensile a giorno metallo L.26,5 H.25 P.12 bianco opaco (x2)

PGM53 Pensile a giorno metallo L.53 H.25 P.12 bianco opaco

G5007C Base unit for washbasin Cx W.70 H.50 D.46 2 drawers corda opaco

TL0746 Closing top W.70 H.2 D.46 noce gold

LSNICE55.05 Counter top basin NICE in ceramic W.55 H.15 D.35,5 bianco opaco

SAL06L Rear lighted mirror ALFA W.60 H.90

T TOUCH switch for mirror

LT03 Led lamp TWO-FACES W.4 H.30 D.2

ASI Magnetised magnifying mirror Ø15

PAV04 Side towel rails VELA W.40 h.4,5 D.7 nero opaco

PGM25 Metal open wall unit W.26,5 H.25 D.12 bianco opaco (x2)

PGM50 Metal open wall unit W.53 H.25 D.12 bianco opaco

composition GEA.09

L 150 H 50 P 46

La base a giorno con struttura in noce gold abbinata all'anta in corda opaco sono un esempio elegante di combinazione di finiture e cromie disponibile nella collezione GEA. Creano un armonioso contrasto le mensoline in metallo nero disponibili anche con ganci portasciugamani.

The open base with noce gold structure combined with the corda opaco door is an elegant example of the combination of finishes and colors available in the GEA collection. The black metal shelves also available with towel hooks create a harmonious contrast.

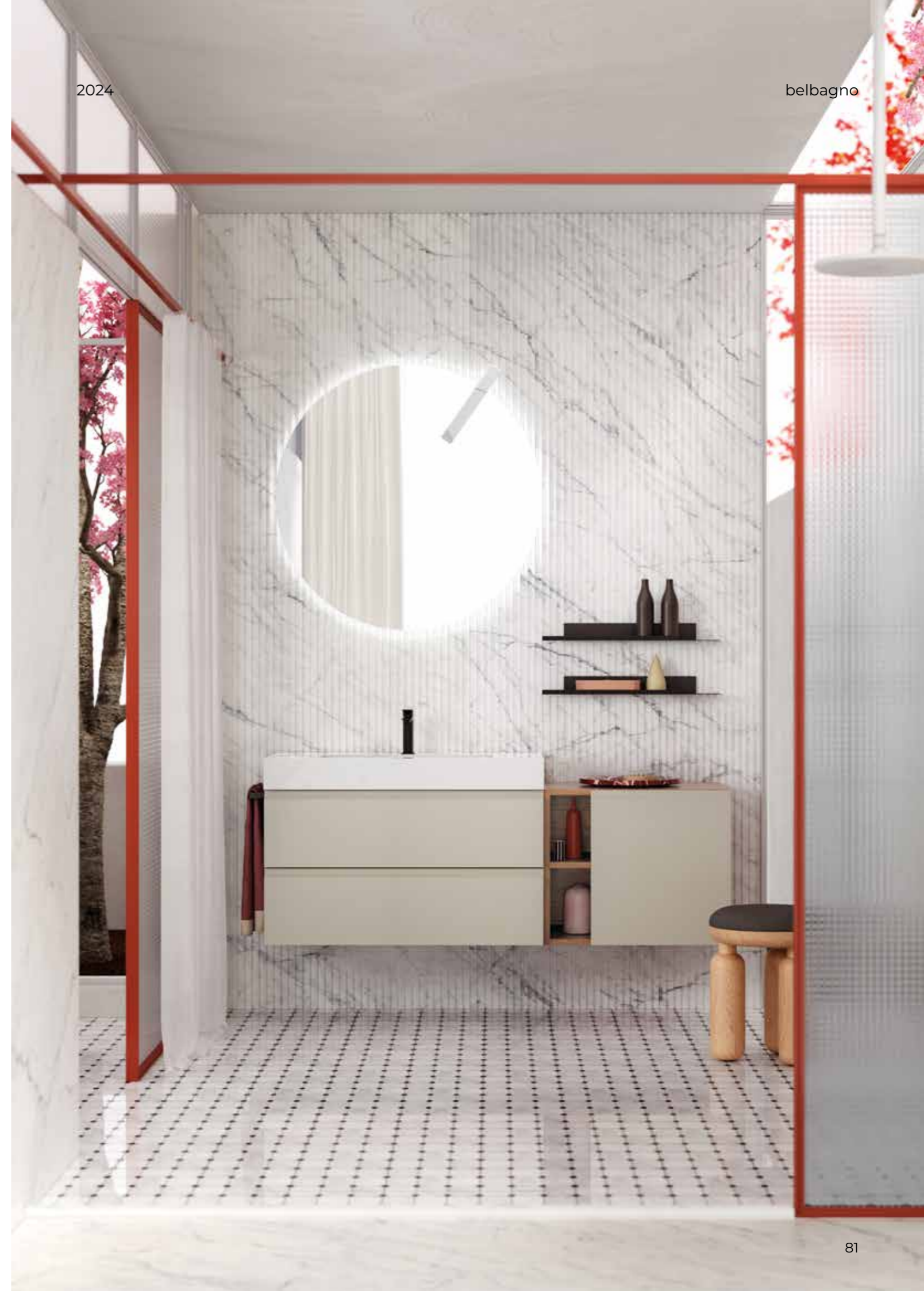

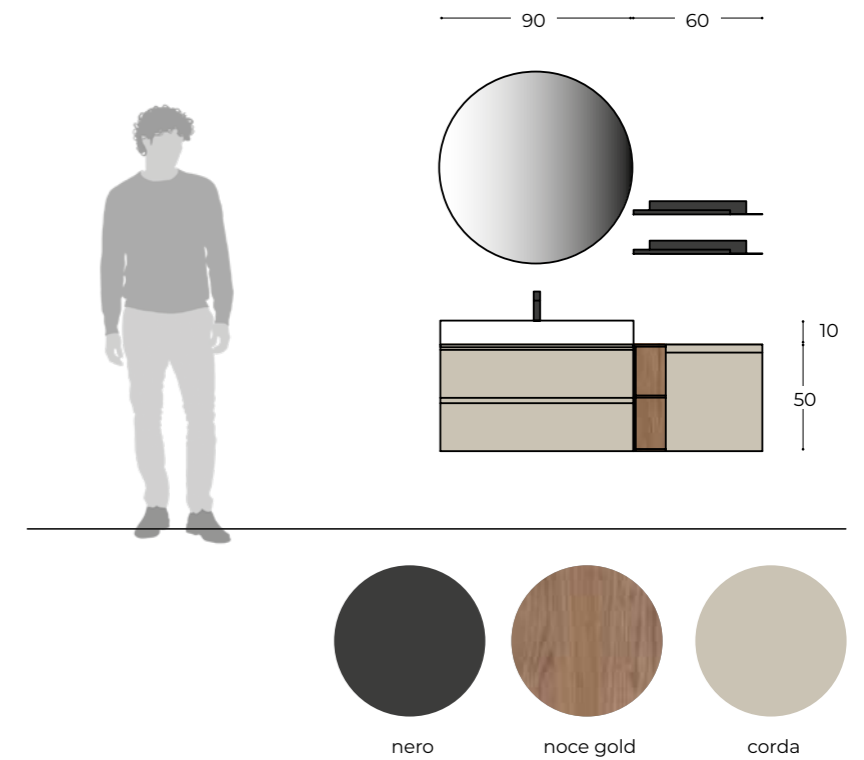

composition GEA.09

L 150 H 50 P 46

G5009C Base portalavabo Cx L.90 H.50 P.46 2 cassetti fianchi noce gold frontali corda opaco

G5006DG Base a giorno L.60 H.50 P.46 noce gold con anta L.45 Dx corda opaco

LSH09C Lavabo integrale SHARK mineralmarmo L.90,5 H.10 P.46 VASCA CX bianco opaco

SA090L Specchiera ARCO Retroilluminata Ø90

LT03 Lampada led TWO-FACES L.4 H.30 P.2

PAV04 Portasciugamani laterale VELA L.40 H.4,5 P.7 nero opaco

MM06 Mensola portaoggetti metallo con ganci L.60 H.6 P.15 nero opaco (x2)

G5009C Base unit for washbasin Cx W.90 H.50 D.46 2 drawers two-tone noce gold and corda opaco

G5006DG Open base W.60 H.50 D.46 noce gold with door RIGHT W.45 corda opaco

LSH09C Integral washbasin SHARK in mineral marble W.90,5 H.10 D.46 CENTRAL BASIN bianco opaco

SA090L Rear lighted mirror ARCO Ø90

LT03 Led lamp TWO-FACES W.4 H.30 D.2

PAV04 Side towel rails VELA W.40 H.4,5 D.7 nero opaco

MM06 Metal shelf W.60 H.50 D.46 with hooks nero opaco (x2)

composition GEA.10

L 140 H 58,7 P 46

Il top scatolare a forte spessore può essere utilizzato in appoggio sulle basi sospese. Disponibile anche nella finitura noce gold si abbina con la struttura delle basi bicolore con frontali in corda. Il gioco di cromie si completa con la proposta total black del lavabo NICE in appoggio con piletta coordinata.

The very thick box top can be used to rest on the suspended bases. Also available in the gold walnut finish, it matches the structure of the two-tone bases with rope fronts. The play of colors is completed with the total black proposal of the NICE washbasin with coordinated waste.



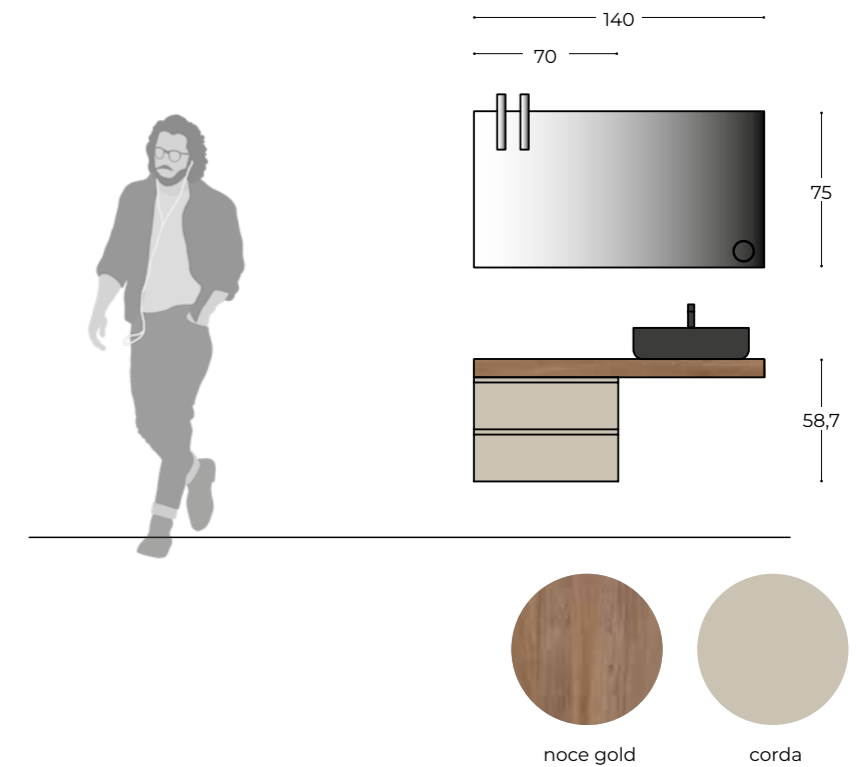

composition GEA.10

L 140 H 58,7 P 46

G50070 Base portalavabo Cx L.70 H.50 P.46 2 cassette fianchi noce gold frontali corda opaco
TS1440 Top scatolare L.140 H.8,7 P.46 noce gold
SM0003 Staffa di montaggio L.42,5 (x2)
LSNICE55.19 Lavabo appoggio NICE ceramica L.55 H.15 P.35,5 D.35,5 nero opaco
PC.19 Piletta ceramica nero opaco
SF1400 Specchiera Filo Lucido L.140 H.75
LT03 Lampada led TWO-FACES L.4 H.30 P.2 (x2)

ASI Specchio ingranditore calamitato Ø15
PAV04 Portasciugamani laterale VELA L.40 H.4,5 P.7 nero opaco

G50070 Base unit for washbasin Cx W.70 H.50 D.46 2 drawers two-tone noce gold and corda opaco
TS1440 Box-shaped top W.140 H.8,7 D.46 noce gold
SM0003 Supporting brackets W.42,5 (x2)
LSNICE55.19 Counter Top basin NICE in ceramic W.55 H.15 D.35,5 D.35,5 nero opaco
PC.19 Waste basin in ceramic nero opaco
SF1400 Polished edge mirror W.140 H.75
LT03 Led lamp TWO-FACES W.4 H.30 D.2 (x2)

ASI Magnetised magnifying mirror Ø15
PAV04 Side towel rails VELA W.40 H.4,5 D.7 nero opaco

composition GEA.11

L 90 H 75 P 46

La struttura in metallo verniciato nero può essere di supporto anche per basi H.25 e integra un pratico ripiano di appoggio nella stessa finitura. Completano la composizione il pensile a giorno con struttura in alluminio e ripiani in vetro e il pensile in metallo bianco opaco.

The black painted metal structure can also support H.25 bases and integrates a practical support shelf in the same finish. The composition is completed by the open wall unit with aluminum structure and glass shelves and the bianco opaco metal wall unit.

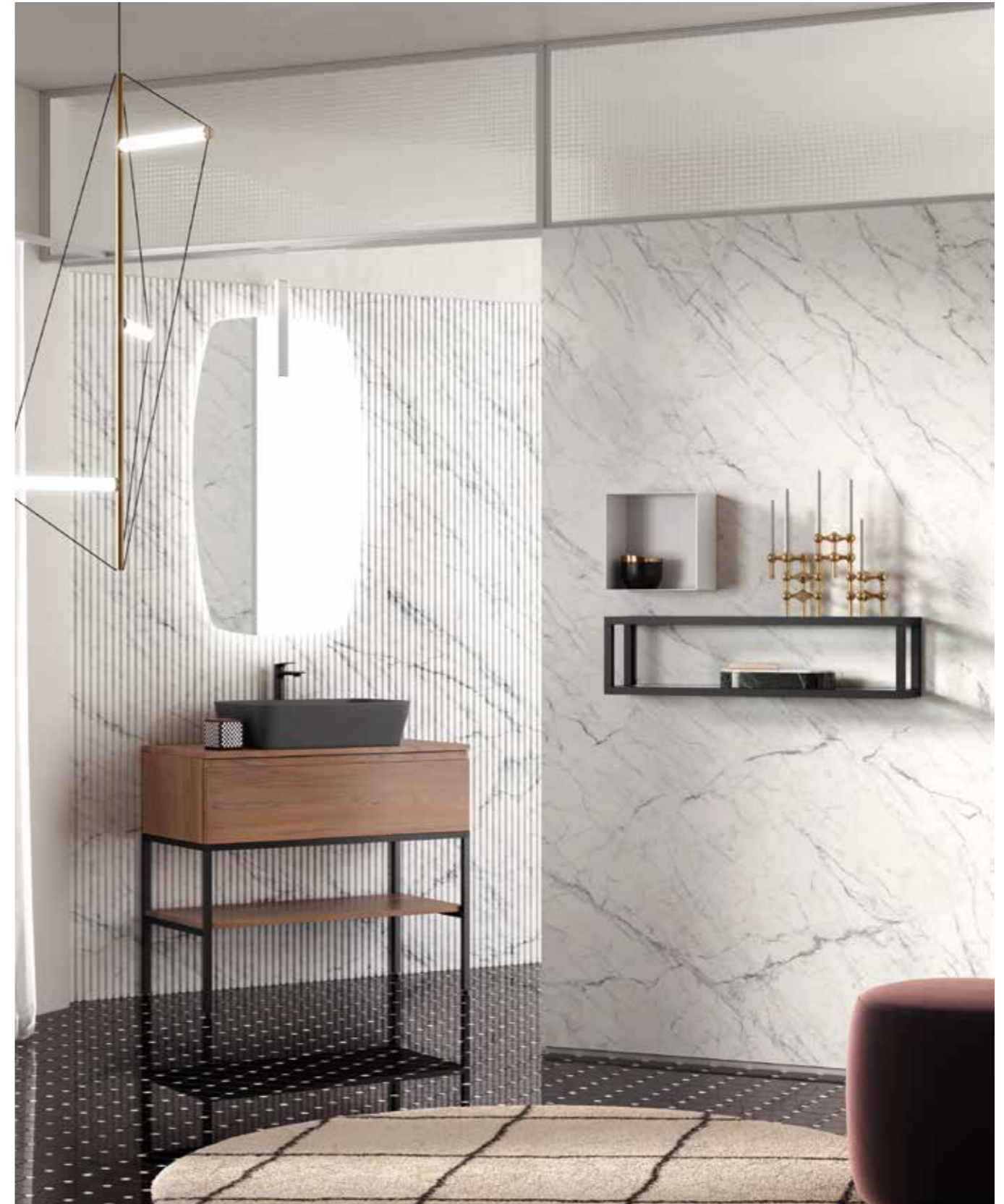

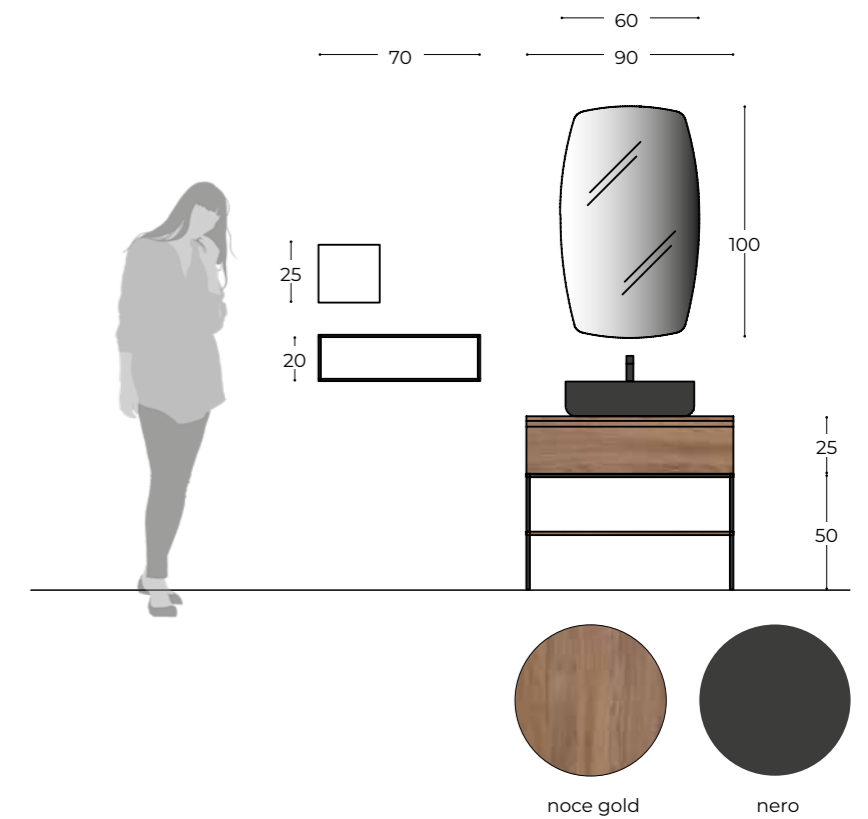

composition GEA.11

L 90 H 75 P 46

G2509C Base portalavabo Cx L.90 H.25 P.46 1 cassetto noce gold

AB5009 Struttura alluminio nero opaco base L.90 H.50 p.46 con ripiano noce gold

TL0946 Top chiusura L.90 H.2 P.46 noce gold

LSSFOG Lavabo appoggio FOGLIA solygel L.55 P.35 H.13,5 antracite

SO060L Specchiera retroilluminata BOTTE L.60 H.100

LT03 Lampada led TWO-FACES L.4 H.30 P.2

AP07 Struttura alluminio pensile nero opaco con ripiano vetro L.70 H.20 P.16

PGM26 Pensile a giorno metallo L.26,5 H.25 P.12 bianco opaco

G2509C Base unit for washbasin Cx W.90 H.25 D.46 1 drawer noce gold

AB5009 Aluminum structure for BASE W.90 H.50 nero opaco with noce gold shelf

TL0946 Closing top W.90 H.2 D.46 noce gold

LSSFOG Counter top basin FOGLIA in solygel W.55 D.35 H.13,5 antracite

SO060L Rear lighted mirror BOTTE W.60 H.100

LT03 Led lamp TWO-FACES W.4 H.30 D.2

AP07 Open unit aluminum structure with glass shelves W.70 H.20 D.16 nero opaco

PGM26 Metal open unit W.26,5 H.25 D.12 bianco opaco

QUOTE BASI PORTALAVABO CX H.25, H.36, H.50
 QUOTAS DISCHARGES BASE UNIT FOR WASHBASIN CX H.25, H.36, H.50

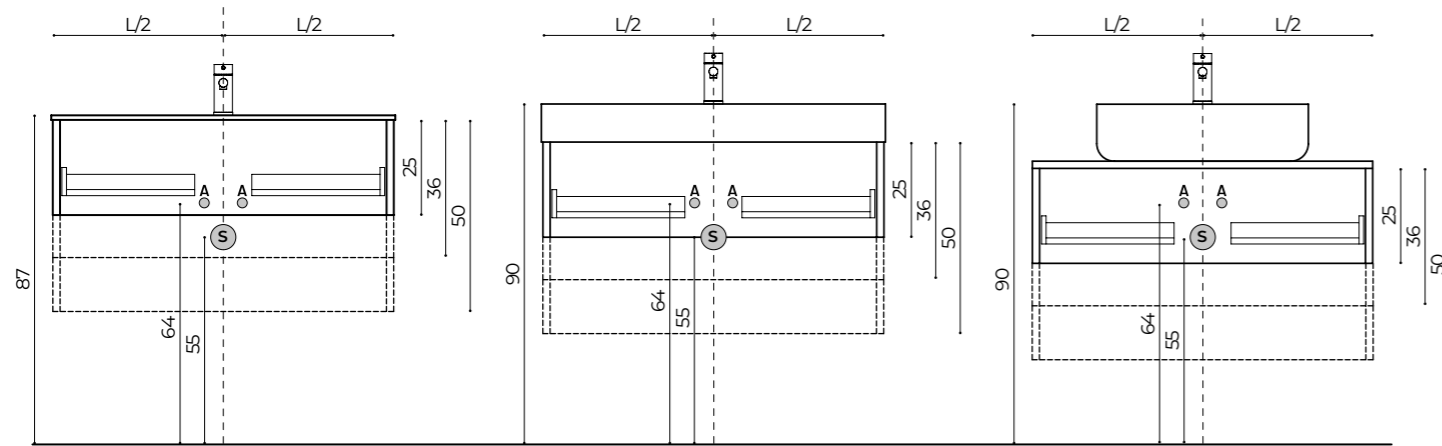

QUOTE BASI PORTALAVABO DOPPIA VASCA CON LAVABO H.1,3 (ES. FIANCHI H.50)
 QUOTAS DISCHARGES BASE UNIT FOR WASHBASIN WITH DOUBLE BASIN WASHBASIN H.1,3 (EX. SIDES H.50)

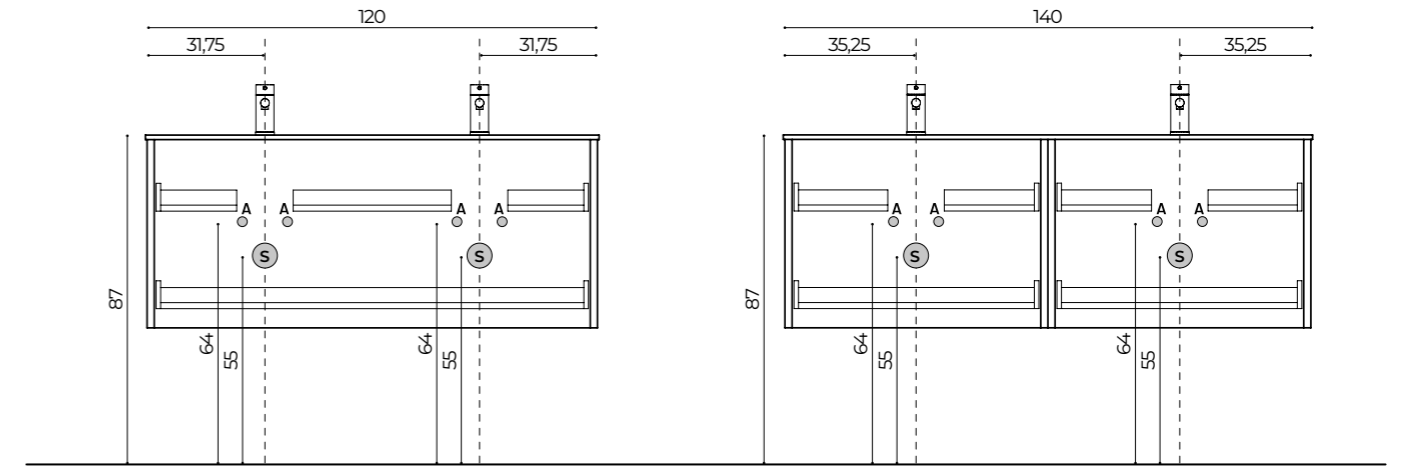

QUOTE BASI PORTALAVABO DECENTRATE CON LAVABO L.120 H.1,3 (ES. FIANCHI H.50)
 QUOTAS DISCHARGES DECENTRALIZED BASE UNIT FOR WASHBASIN WITH WASHBASIN W.120 H.1,3 (EX. SIDES H.50)

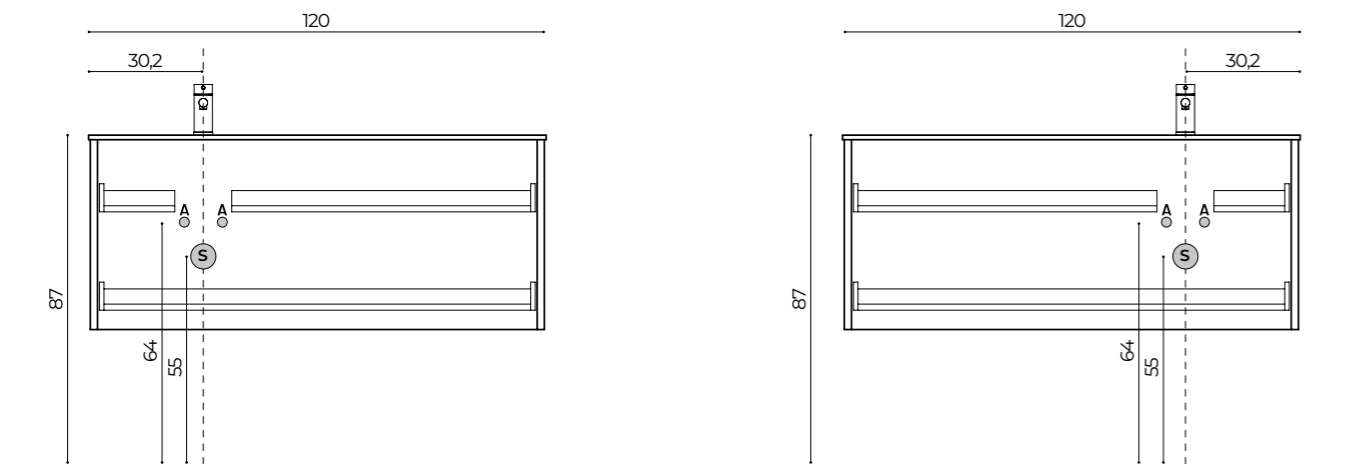

QUOTE BASI PORTALAVABO DOPPIA VASCA CON LAVABO SHARK H.10 (ES. FIANCHI H.50)
 QUOTAS DISCHARGES BASE UNIT FOR WASHBASIN WITH DOUBLE BASIN WASHBASIN SHARK H.10 (EX. SIDES H.50)

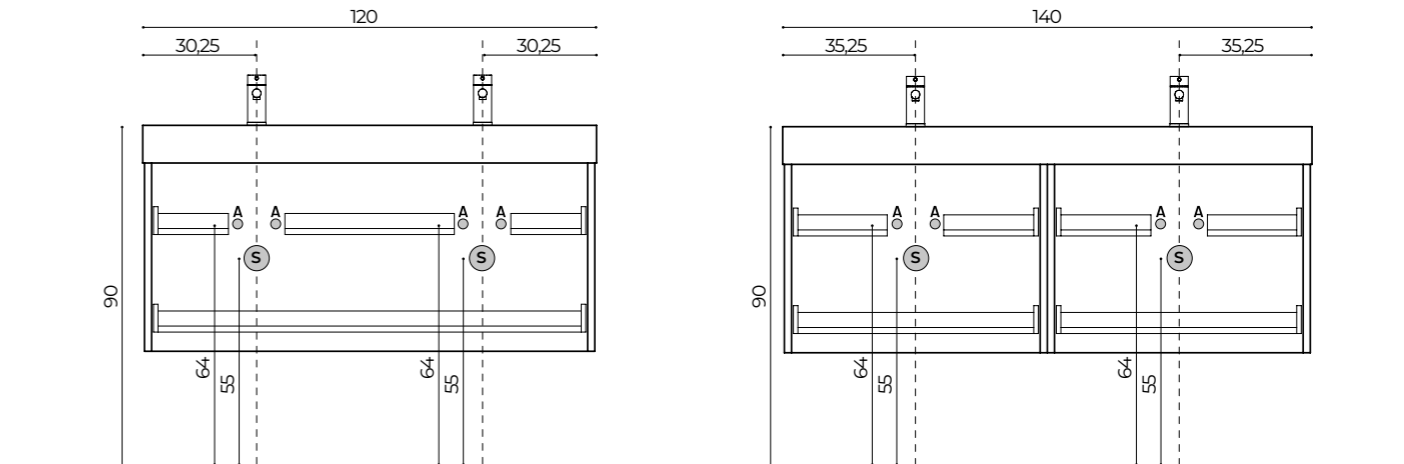

QUOTE BASI PORTALAVABO DECENTRATE CON LAVABO L.100 (70+30)/L.120 (90+30) H.1,3 (ES. FIANCHI H.50)
 QUOTAS DISCHARGES DECENTRALIZED BASE UNIT FOR WASHBASIN WITH WASHBASIN W.100 (70+30) / W.120 H.1,3 (EX. SIDES H.50)

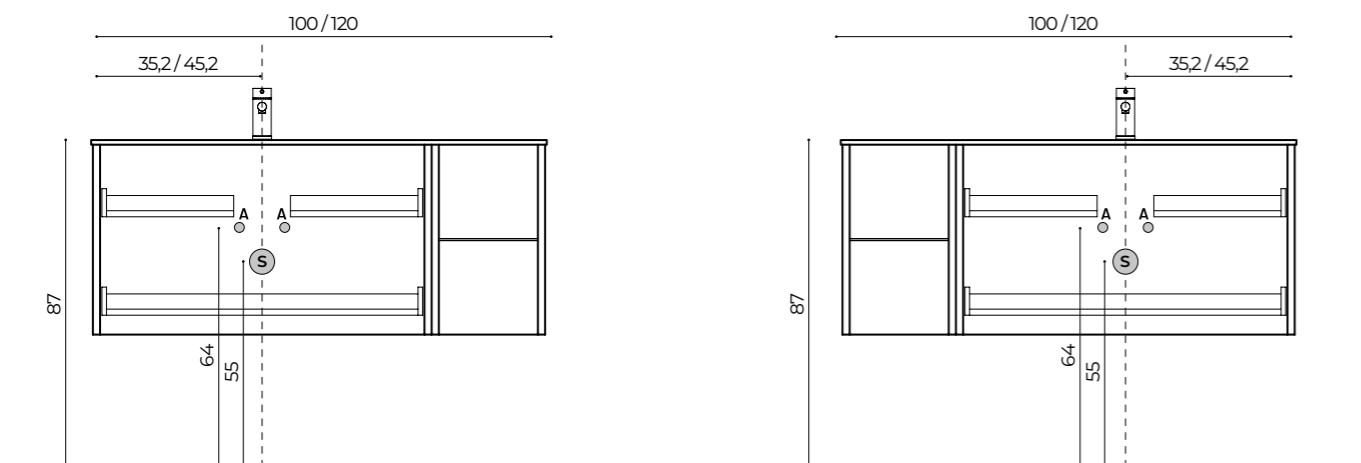

QUOTE PER TOP SCATOLARI CON BASI H.25
 QUOTAS DISCHARGES FOR BOX-SHAPED WITH BASE UNIT H. 25

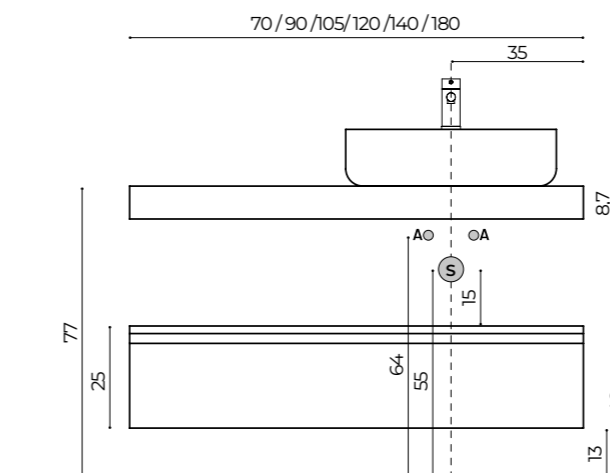

QUOTE PER TOP SCATOLARI CON BASI H.36
 QUOTAS DISCHARGES FOR BOX-SHAPED WITH BASE UNIT H. 36

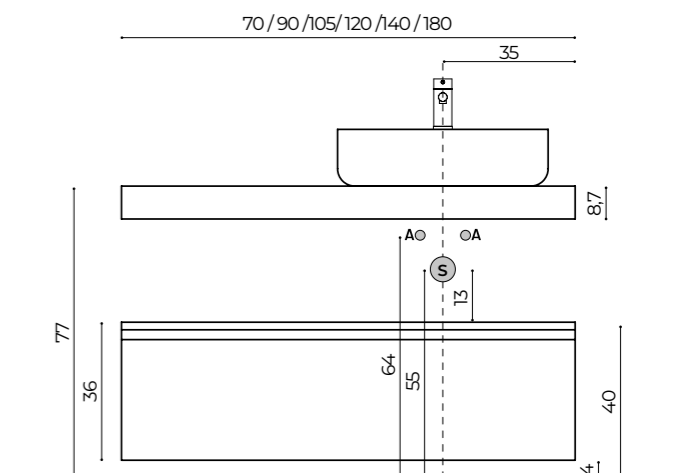

L'ALTEZZA DA TERRA DELLO SCARICO E' 55 CM / THE HEIGHT OF THE DRAINAGE OUTFLOW PIPE TO THE FLOOR IS 55CM.

LISTINO

Il presente listino è espresso in Euro e le sue quotazioni s'intendono riservate al pubblico Iva esclusa. Belbagnò Italia srl, al fine di migliorare le caratteristiche tecniche e qualitative della sua produzione, si riserva di apportare, in qualunque momento e senza preavviso, tutte le modifiche che si rendessero necessarie agli elementi illustrati nel presente catalogo. Declina ogni responsabilità per eventuali inesattezze contenute nello stesso. I colori e i materiali riprodotti nelle immagini stampate hanno un valore puramente indicativo.

DECORRENZA

Le presenti quotazioni decorrono dal Gennaio 2023 ed annullano e sostituiscono qualsiasi offerta precedente.

ORDINI

Gli ordini sono accettati con la clausola "salvo approvazione della casa" anche quando non espressamente scritto negli stessi.

Gli ordini anticipati telefonicamente devono essere seguiti da conferma scritta; in caso contrario non ci riterremo responsabili per eventuali errori.

Le conferme d'ordine da noi inviate vengono considerate accettate nulla ricevendo entro 48 ore.

INSTALLAZIONE DEL PRODOTTO

La ditta Belbagnò Italia s.r.l respinge ogni responsabilità per montaggio errato e consiglia di avvalersi di personale qualificato in rispetto delle norme in materia. L'installazione corretta del prodotto garantisce la maggior durata nel tempo dello stesso.

RECLAMI

Le contestazioni per danni causati dal trasporto devono essere effettuate tassativamente al momento dello scarico. E' diritto e responsabilità del cliente verificare l'integrità dell'imballo originale al momento della consegna, che deve essere nelle stesse condizioni in cui è partito dalla mittente; qualora l'imballo riporti evidenti segni di collisione o manomissione il destinatario è tenuto a riportare in bolla, in presenza dell'autista, riserva specifica indicando lo stato reale dell'imballo. Belbagnò Italia s.r.l. declina ogni responsabilità per i danni rilevati da ulteriori destinazioni diverse da quella di destino. Eventuali reclami per difetti di fabbricazione devono essere rilevati mediante lettera raccomandata entro 8 gg. dal ricevimento della merce. Non si accettano reclami su difetti di fabbricazione per elementi installati.

GARANZIE

I prodotti Belbagnò Italia s.r.l. sono garantiti per la durata di 24 mesi solo per quei difetti imputabili alla produzione.

RESI

I resi per difetti di produzione dovranno essere autorizzati per iscritto dalla ditta BelBagnò Italia s.r.l e dovranno pervenire accuratamente protetti ed imballati. Nel caso in cui al prodotto reso non vengano riscontrati difetti di produzione lo stesso sarà rispedito al cliente, addebitando le spese di trasporto.

PAGAMENTO

In caso di ritardato pagamento decorreranno interessi commerciali nella misura di cinque punti percentuale oltre il tasso di sconto vigente.

RISERVA DI PROPRIETA'

La merce rimane di proprietà della ditta Belbagnò Italia s.r.l. fino al completo pagamento della fattura di riferimento ed eventuali interessi di mora.

FORO COMPETENTE

Ogni controversia connessa alle presenti condizioni generali sarà devoluta alla competenza esclusiva del foro di Pesaro Urbino.

CONSEGNA E TRASPORTO (vedere tabella sotto)

Le consegne saranno effettuate nei tempi stabiliti dal ns. ufficio commerciale. Per consegne con importo inferiore ad Euro 400,00 viene addebitato un contributo di trasporto pari ad Euro 35,00. (40,00 Euro per Calabria, Sicilia, Sardegna).

SPEDIZIONI: PER ORDINI INFERIORI A € 400,00

ITALIA	CALABRIA - SICILIA - SARDEGNA
€ 35,00 (per pallet)	€ 40,00 (per pallet)

PRICE LIST

This price list is expressed in Euros and its prices are intended for the public excluding VAT. In order to improve technical and qualitative characteristics of its production the company Belbagnò Italia Srl reserves the right to make all necessary changes of the products illustrated in the catalogue at any time and without giving any prior notice. The company declines all responsibility for any inaccuracies the catalogue contains. The colors and materials portrayed in the printed images are purely indicative.

EFFECTIVE DATE

Prices are effective from January 2023 and they cancel and replace any previous offer.

ORDERS

The orders are accepted with the clause "subject to the manufacturer's approval" even if not expressly written. The orders by telephone must be followed by a written confirmation; otherwise we will not be responsible for any mistakes. The confirmations sent are considered accepted within 48 hours.

INSTALLATION OF THE PRODUCT

Belbagnò Italia s.r.l. rejects any responsibility for incorrect assembly and recommends to use qualified employees in compliance with the relevant regulations. The correct installation of the product ensures a longer lifetime of the product.

COMPLAINTS

Complaints about defected damages during the transport must be strictly disputed at the time of unloading. It is the customer's right and responsibility to verify the integrity of the original packaging at the time of the delivery, which it must be in the same condition in which it left from the sender; if the packaging shows obvious signs of collision or tampering the recipient is required to report on the delivery note a specific reserve indicating the real state of the packaging in the presence of the driver. Belbagnò Italia s.r.l. disclaims any responsibility for detected damages by other destinations other than those contractually intended. Any complaints for manufacturing defects must be notified by registered mail within 8 days of the receipt of goods. We do not accept complaints about manufacturing defects for installed elements.

WARRANTY

Products are guaranteed for 24 months for all those defects caused by manufacturing.

RETURNS

Returns for manufacturing defects must be authorized in writing from BelBagnò Italia s.r.l. and must be received carefully protected and packaged. In case we don't find manufacturing defects the product will be sent back to the customer with the surcharge of the transport costs.

PAYMENT

In case of late payment for commercial interests you will be charged to the extent of five percentage points above the current discount rate.

RESERVATION OF OWNERSHIP

The goods remains the property of Belbagnò Italia s.r.l. until the full payment of the invoice and for any related interest on late payment.

PLACE OF JURISDICTION

Any complaint related to these general conditions will be devolved to the exclusive jurisdiction of the district court of Pesaro Urbino.

DELIVERY AND TRANSPORT (see table below)

Deliveries will be made within the deadline established by our commercial office. The transport fee for deliveries with an amount lower than € 400.00 is € 35.00 (40.00 Euros for Calabria, Sicily, Sardinia). Failure or delayed delivery does not constitute any right relating to compensation for damages. We don't make deliveries to private individuals.

SHIPPING: FOR ORDERS BELOW € 400,00

ITALY	CALABRIA - SICILY - SARDINIA
€ 35,00 (for each pallet)	€ 40,00 (for each pallet)

ESSENZE POLIMERICHE LIDIA / LIDIA POLYMERIC ESSENCES

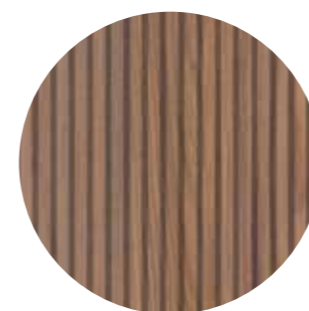

noce gold



rovere chiaro

ESSENZE POLIMERICHE PLUS + / POLYMERIC ESSENCES PLUS +



calacatta chiaro

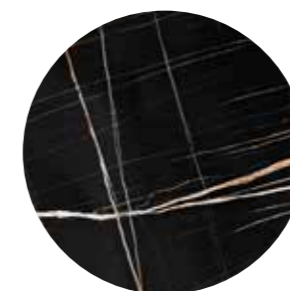

nero marquinia



ossido

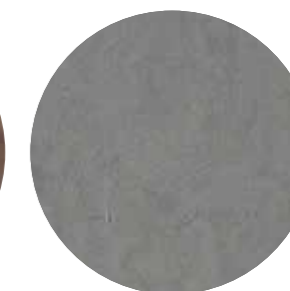

malta chiaro

Belbagnò Italia srl, al fine di migliorare le caratteristiche tecniche e qualitative della sua produzione, si riserva di apportare, in qualunque momento e senza preavviso, tutte le modifiche che si rendessero necessarie agli elementi illustrati nel presente catalogo. Declina ogni responsabilità per eventuali inesattezze contenute nello stesso. I colori e i materiali riprodotti nelle immagini stampate hanno un valore puramente indicativo.

In order to improve technical and qualitative characteristics of its production the company Belbagnò Italia Srl reserves the right to make all necessary changes of the products illustrated in the catalogue at any time and without giving any prior notice. The company declines all responsibility for any inaccuracies the catalogue contains. The colors and materials portrayed in the printed images are purely indicative.



BELBAGNO ITALIA srl

Via Prov.le Feltresca, 6 - 61020
Borgo Massano di Montecalvo in Foglia
Pesaro Urbino / Italy
T/F +39.0722.580131

info@belbagnoitavia.it
www.belbagnoitavia.it